



Universiti
Malaysia
PAHANG
Engineering • Technology • Creativity



SEMINAR SAINTIS MUSLIM MUDA^{2.0}

29 SEPTEMBER 2018 (SABTU)

DEWAN KULIAH 1, FAKULTI KEJURUTERAN PEMBUATAN, UMP KAMPUS PEKAN

ANJURAN :



PIMPIN
PUSAT RISET & PENGUJIAN INDUSTRI
UNIVERSITI MALAYSIA PAHANG

DENGAN KERJASAMA :



مجلس علماء اسلام و
ادب ملايو پاهان
MAJLIS UGAMA ISLAM DAN ADAT BERANG MELAYU PAHANG



SLOT 1

**IBRAH TEKNOLOGI
MADU LEBAH KELULUT**

PROFESOR IR. TS. DR. AHMAD ZIAD
BIN SULAIMAN

SLOT 3

**MENEROKA FORMULASI SAINTIFIK
KIBLAT DAN TAKWIM SOLAT**

USTAZ AHMAD IRFAN BIN
IKMAL HISHAM

SLOT 2

**APLIKASI KAWALAN BIOLOGI
BERTERASKAN AL QURAN**

ENCIK ABDUL SYUKOR BIN
ABDUL RAZAK

SLOT 4

BICARAWARA SAINS ISLAM

DR. MAT ROFA BIN ISMAIL

(يُؤْتِي الْحِكْمَةَ مَنْ يَشَاءُ وَمَنْ يُؤْتَ
الْحِكْمَةَ فَقَدْ أُوتِيَ خَيْرًا كَثِيرًا وَمَا يَذَّكَّرُ إِلَّا
أُولُو الْأَلْبَابِ)

[سورة البقرة الآية: 269]

He grants wisdom to whom He pleases; and whoever is granted wisdom is indeed given a great wealth, yet none except people of understanding learn a lesson from it.

(إِنَّ فِي خَلْقِ السَّمَاوَاتِ وَالْأَرْضِ وَاخْتِلَافِ اللَّيْلِ
وَالنَّهَارِ لَآيَاتٍ لِأُولِي الْأَبْصَارِ * الَّذِينَ يَذْكُرُونَ اللَّهَ
قِيَامًا وَقُعُودًا وَعَلَىٰ جُنُوبِهِمْ وَيَتَفَكَّرُونَ فِي خَلْقِ
السَّمَاوَاتِ وَالْأَرْضِ رَبَّنَا مَا خَلَقْتَ هَذَا بَاطِلًا
سُبْحَانَكَ فَقِنَا عَذَابَ النَّارِ)

[آل عمران: 190-191].



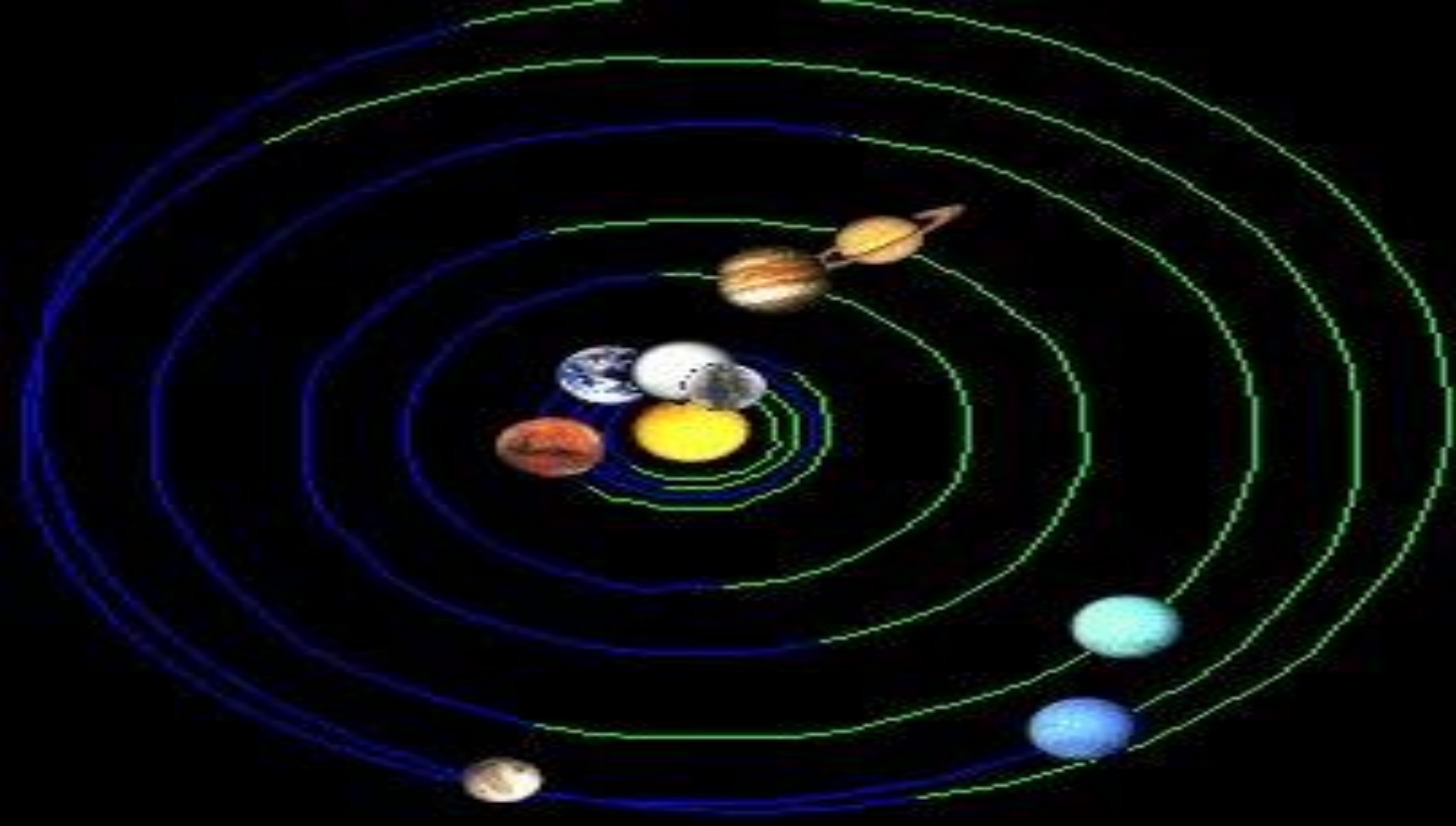

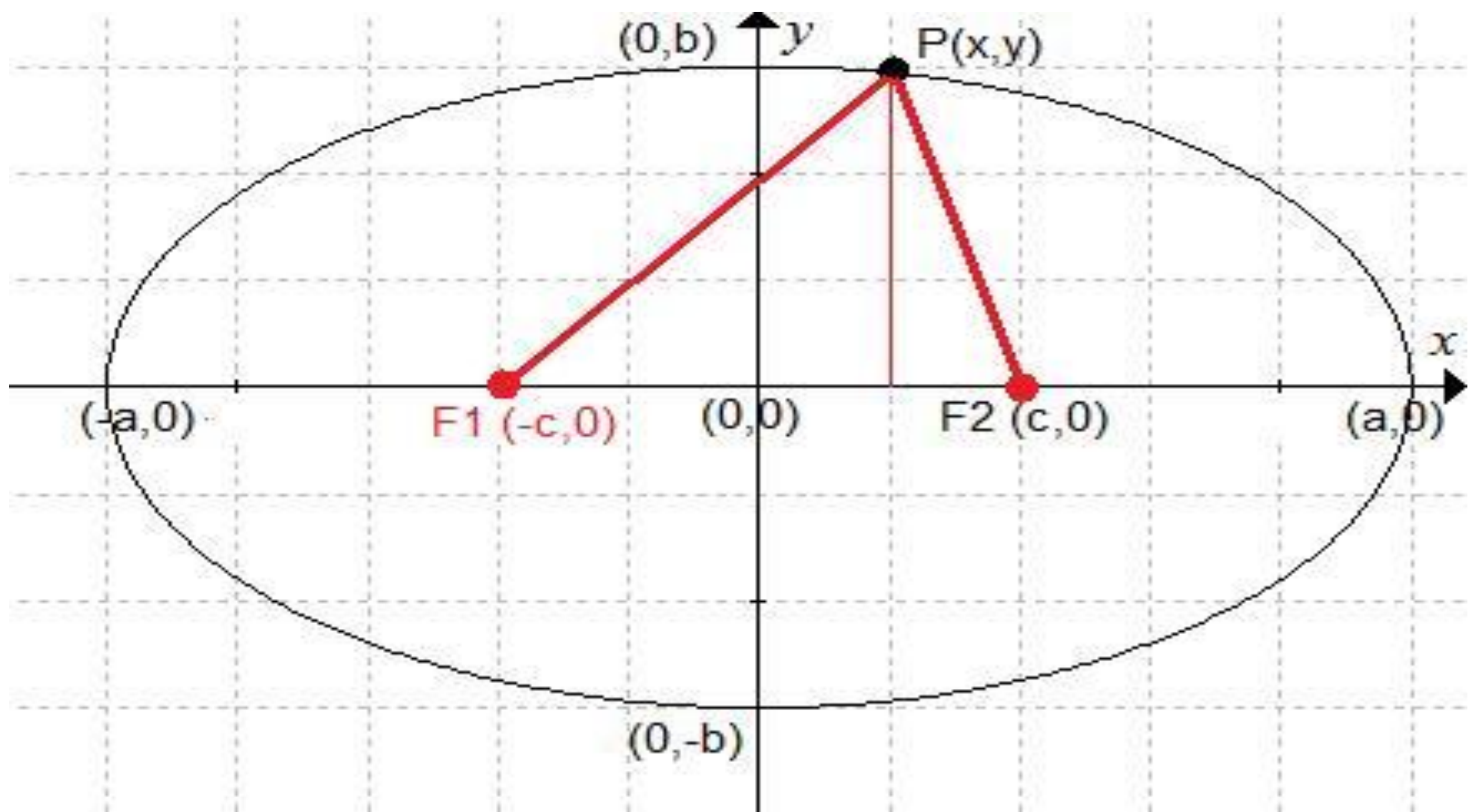

(وَالشَّمْسُ تَجْرِي لِمُسْتَقَرٍّ لَهَا ذَلِكَ تَقْدِيرُ الْعَزِيزِ الْعَلِيمِ (38) وَالْقَمَرَ
قَدَرْنَا مِنْ نَاهُ مَنَازِلَ حَتَّىٰ عَادَ كَالْعُرْجُونِ الْقَدِيمِ (39) لَا الشَّمْسُ يَنْبَغِي لَهَا
أَنْ تُدْرِكَ الْقَمَرَ وَلَا اللَّيْلُ سَابِقُ النَّهَارِ وَكُلٌّ فِي فَلَكٍ يَسْبَحُونَ (40))

(سورة يس)

مركز المجرة

حركة باتجاه مركز المجرة

مستقر الشمس

Solar Apex

الشمس

حركة دورانية حول مركز المجرة



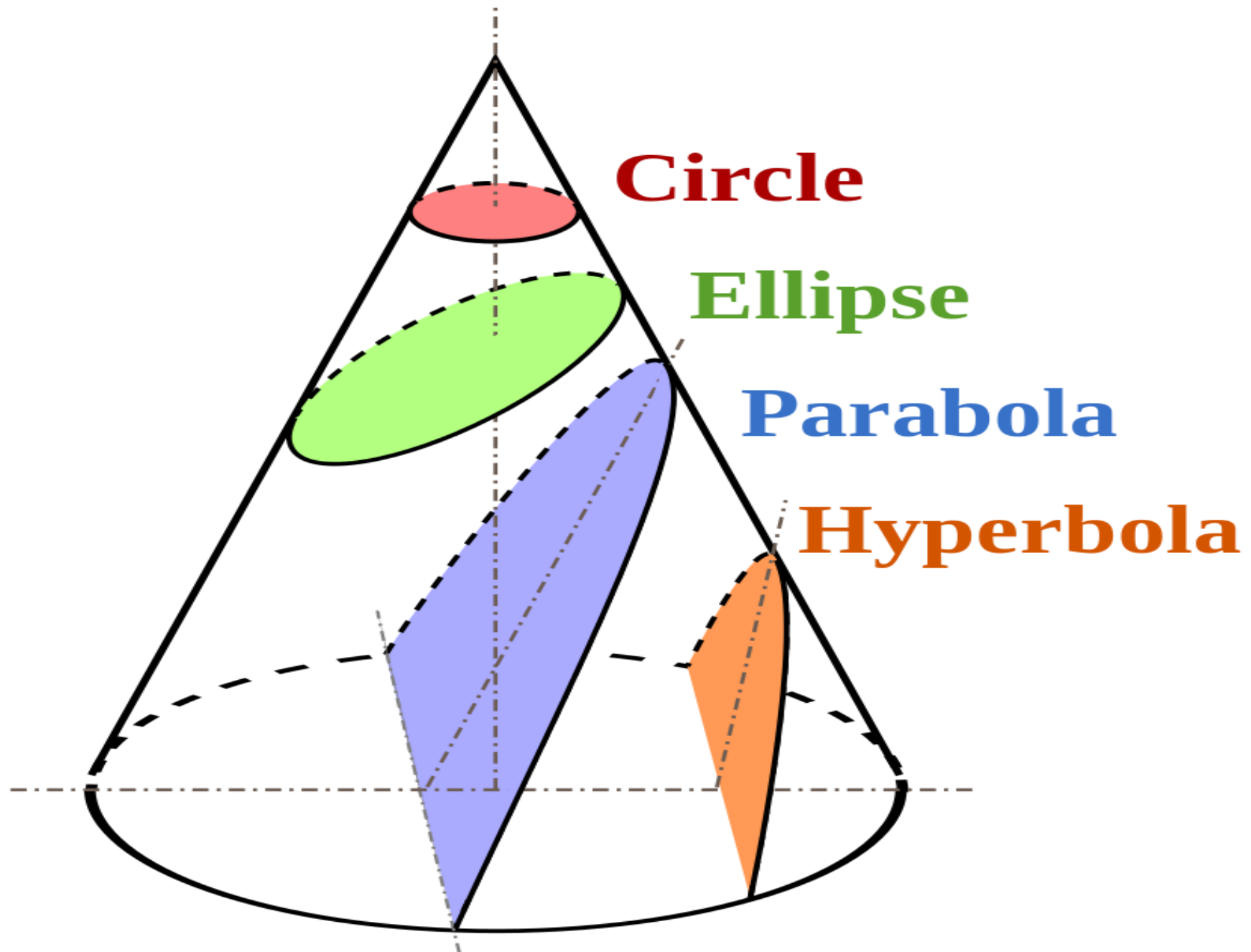

Circle

$$(x - h)^2 + (y - k)^2 = r^2$$

MATHguide.com**Horizontal Axis****Vertical Axis****Parabola**

$$x = a(y - k)^2 + h$$

$$y = a(x - h)^2 + k$$

Ellipse

$$\frac{(x - h)^2}{a^2} + \frac{(y - k)^2}{b^2} = 1$$

$$a^2 > b^2$$

$$f = \sqrt{a^2 - b^2}$$

$$\frac{(x - h)^2}{a^2} + \frac{(y - k)^2}{b^2} = 1$$

$$b^2 > a^2$$

$$f = \sqrt{b^2 - a^2}$$

Hyperbola

$$\frac{(x - h)^2}{a^2} - \frac{(y - k)^2}{b^2} = 1$$

$$f = \sqrt{a^2 + b^2}$$

$$\frac{(y - k)^2}{b^2} - \frac{(x - h)^2}{a^2} = 1$$

$$f = \sqrt{a^2 + b^2}$$

Golden Triangle

for Fibonacci numbers F

$$F_i = \frac{\phi^i - \phi^{-i}}{\sqrt{5}}$$

$$\text{, where } \phi = \frac{1 + \sqrt{5}}{2}$$

$$\phi^n = F_n \phi + F_{n-1}$$

$$\phi = \lim_{n \rightarrow \infty} \frac{F_n}{F_{n-1}}$$

$$\phi^2 = 1 + \phi$$

$$\phi = \frac{1 + \sqrt{5}}{2}$$

$$\phi^n = \phi^{n-1} + \phi^{n-2}$$

$$\phi = \sqrt{1 + \sqrt{1 + \sqrt{1 + \sqrt{1 + \dots}}}}$$

$$\sin\left(\frac{\pi}{2} - i \ln \phi\right) = \frac{\sqrt{5}}{2}$$

$$\sin(i \ln \phi) = \frac{i}{2}$$

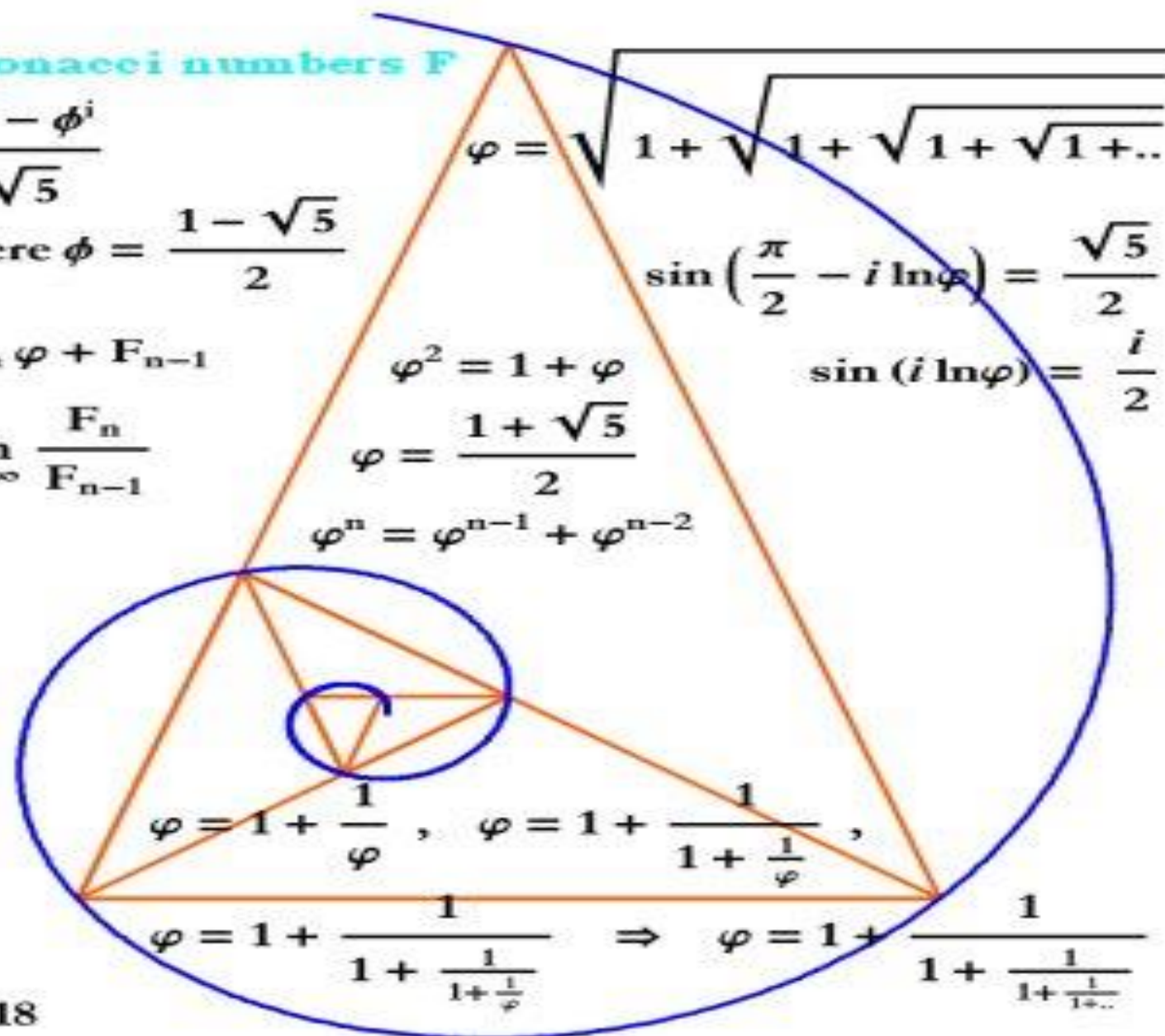

$$\phi = 1 + \frac{1}{\phi}, \quad \phi = 1 + \frac{1}{1 + \frac{1}{\phi}}$$

$$\phi = 1 + \frac{1}{1 + \frac{1}{1 + \frac{1}{\phi}}} \Rightarrow \phi = 1 + \frac{1}{1 + \frac{1}{1 + \dots}}$$

$$\phi \approx 1.618$$



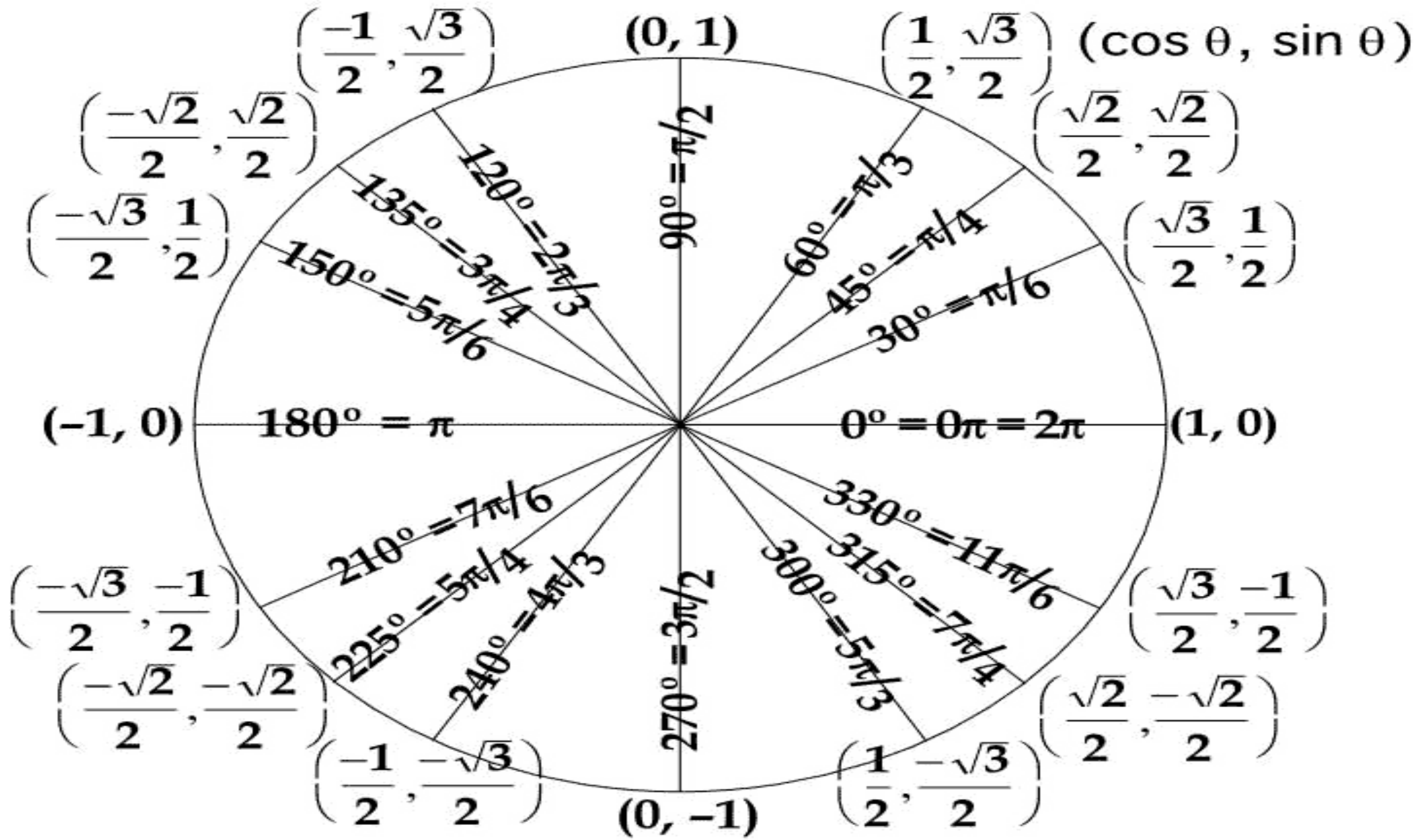

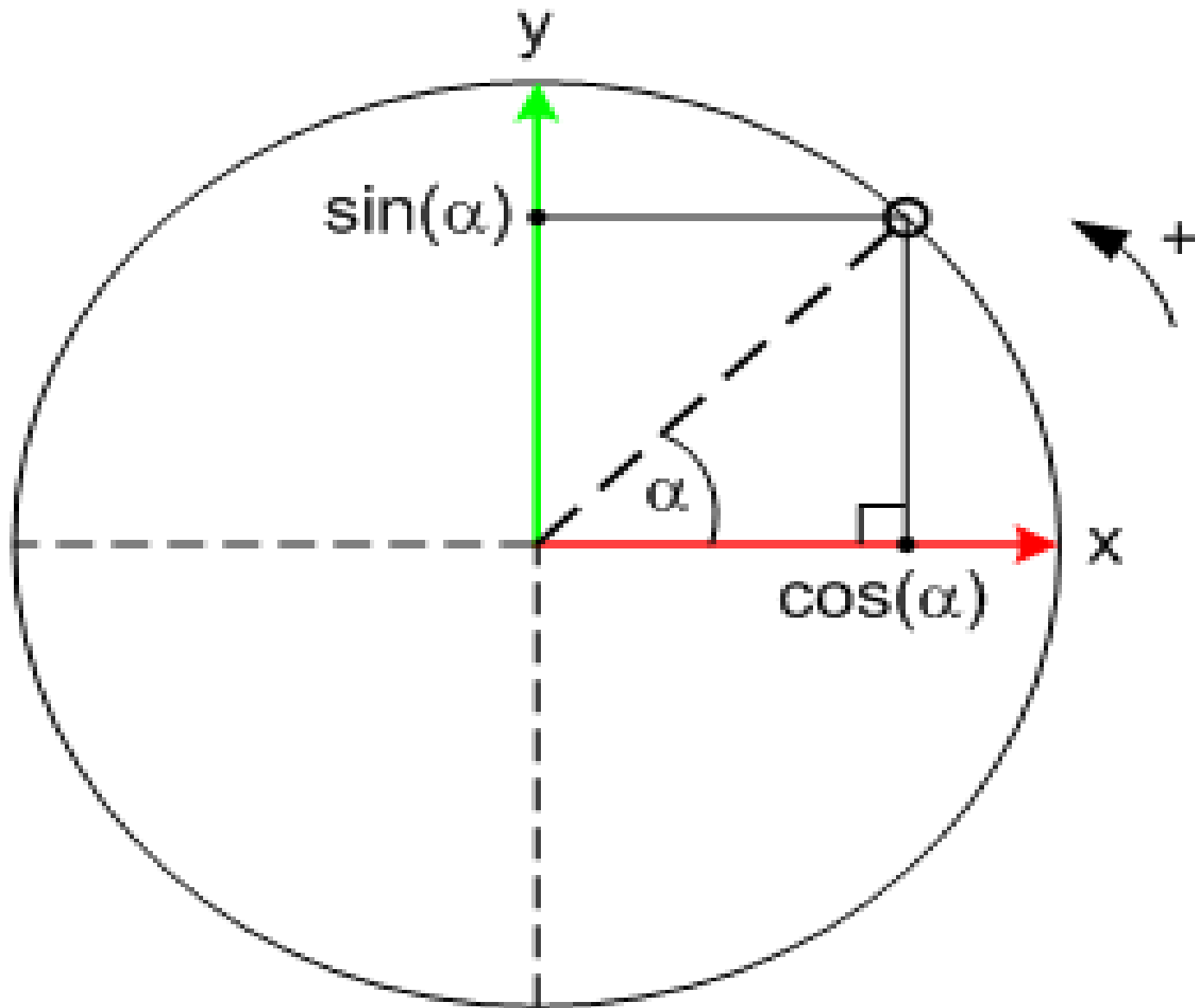

جا (جيب) = \sin
 (الزاوية) = المقابل
 / الوتر

جتا (جيب) = \cos
 (تمام الزاوية) =
 المجاور / الوتر

ظا (ظل) = \tan
 (الزاوية) = المقابل
 / المجاور

«جوجل» تحتفل بذكرى ميلاد عالم الرياضيات «أبو الوفاء
البوزجاني»

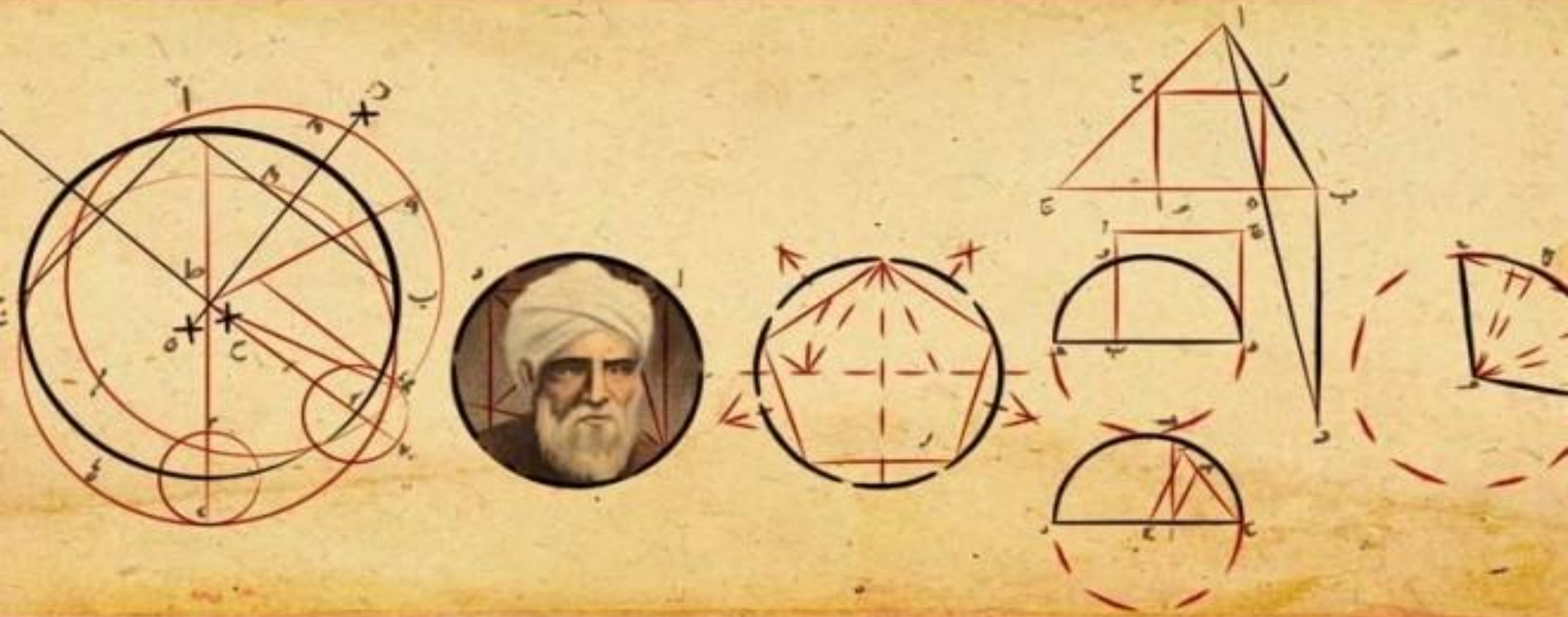



$$\sin(a + b) = \sin(a) \cos(b) + \cos(a) \sin(b)$$

$$\cos(2a) = 1 - 2 \sin^2(a)$$

$$\sin(2a) = 2 \sin(a) \cos(a)$$

$$\frac{\sin(A)}{\sin(a)} = \frac{\sin(B)}{\sin(b)} = \frac{\sin(C)}{\sin(c)}$$



محيط الدائرة

$$\frac{\text{طول محيط الدائرة}}{\text{طول قطر الدائرة}} = \pi$$

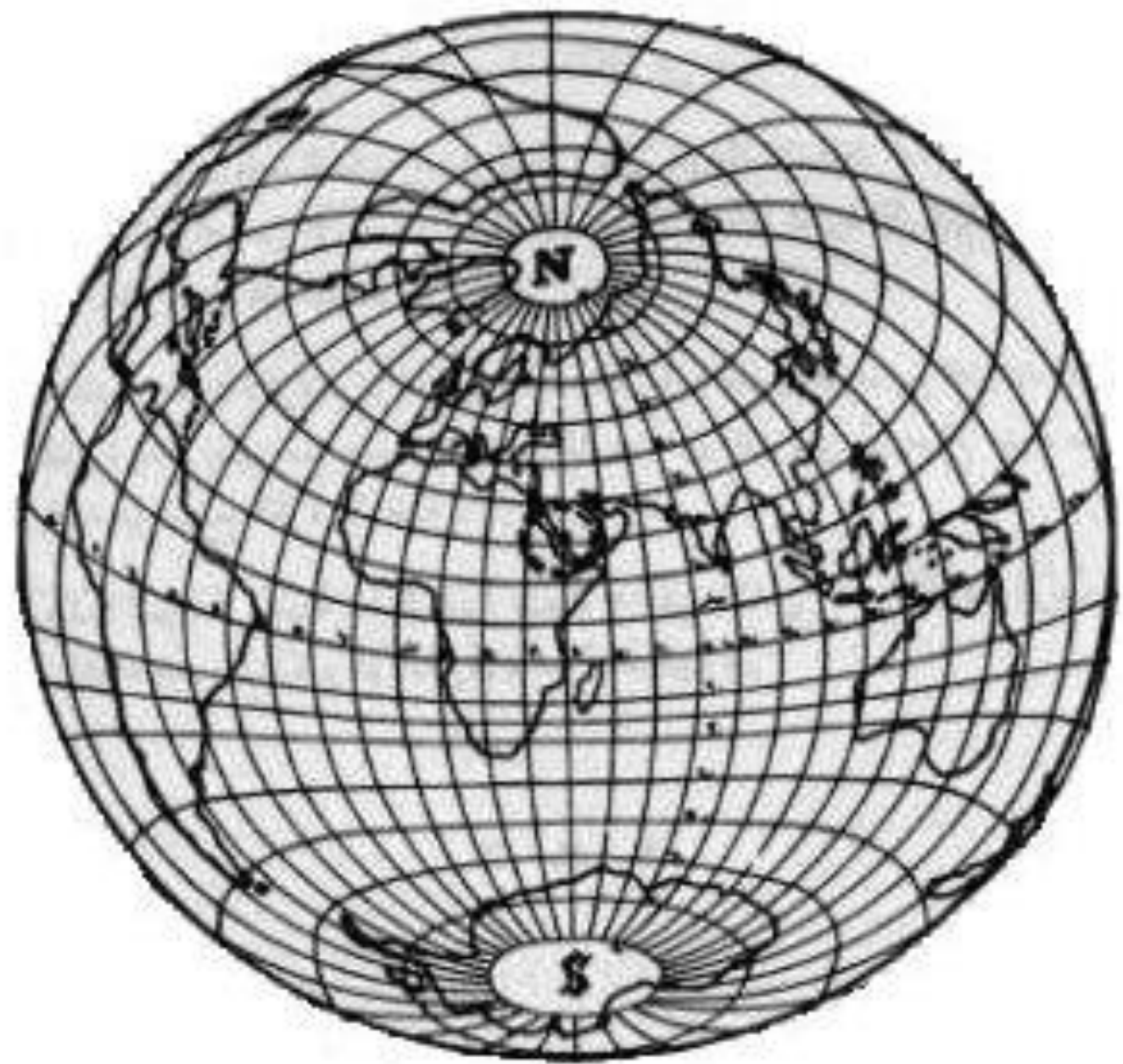

$$\text{tg } K = \frac{\sin(\lambda_t - \lambda_K)}{\cos \varphi_t \cdot \tan \varphi_K - \sin \varphi_t \cdot \cos(\lambda_t - \lambda_K)}$$

K = sudut Arah Kiblat dari Utara ke Barat

φ_K = lintang Ka'bah (21° 25' LU)

λ_K = bujur Ka'bah (39° 50' BT)

φ_t = lintang Tempat / Kota

λ_t = bujur Tempat / Kota



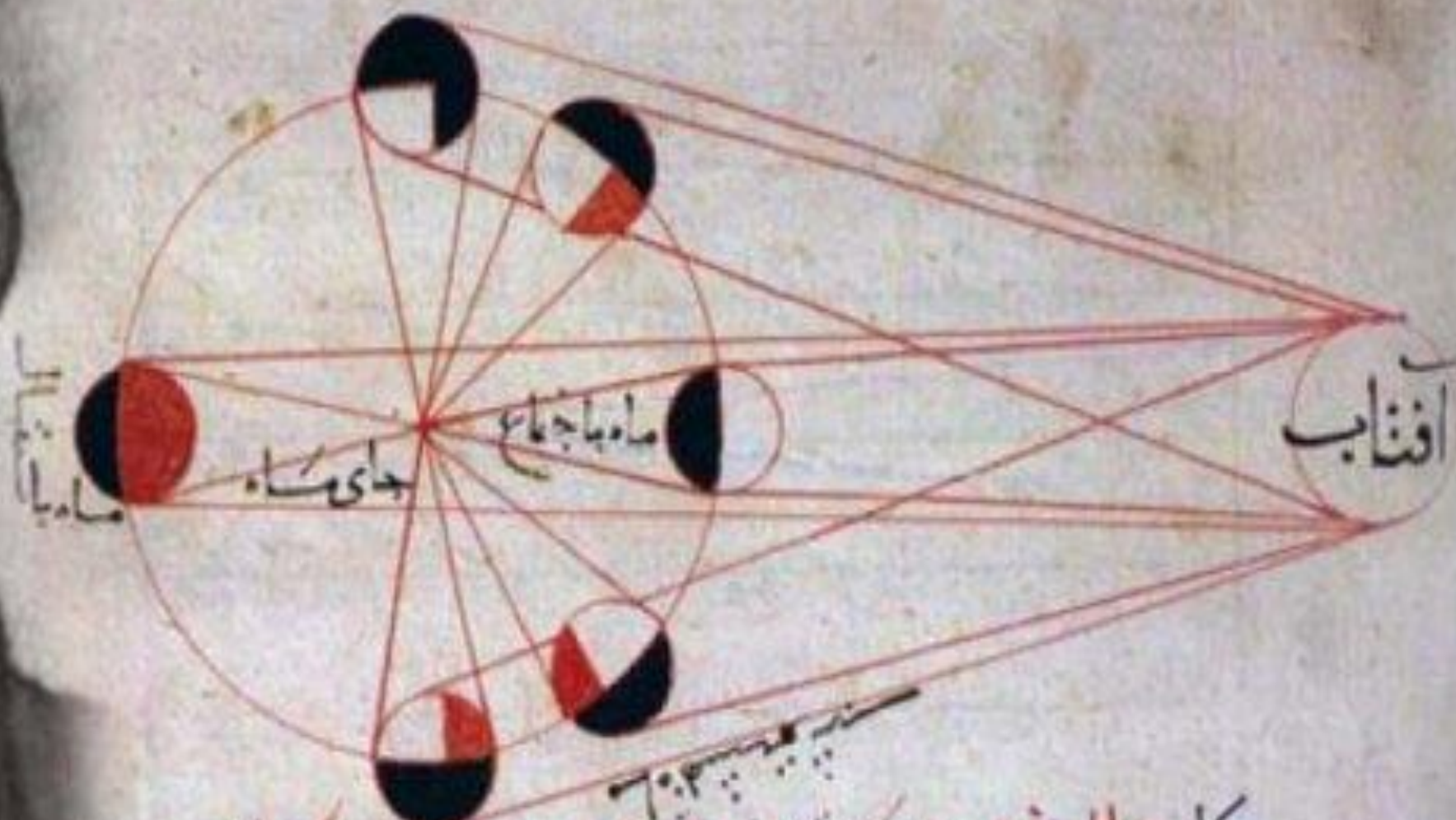

چرا جو این فرودن و کاستن نور را از دست و سمنارگان دیگر را بفرست
میان مردمان نگه داشتن و ناستندن این معنی بهار اخلافت
در روشنائی مشارکان که ایشان را روشنائی از خویشتر است

Total Eclipse

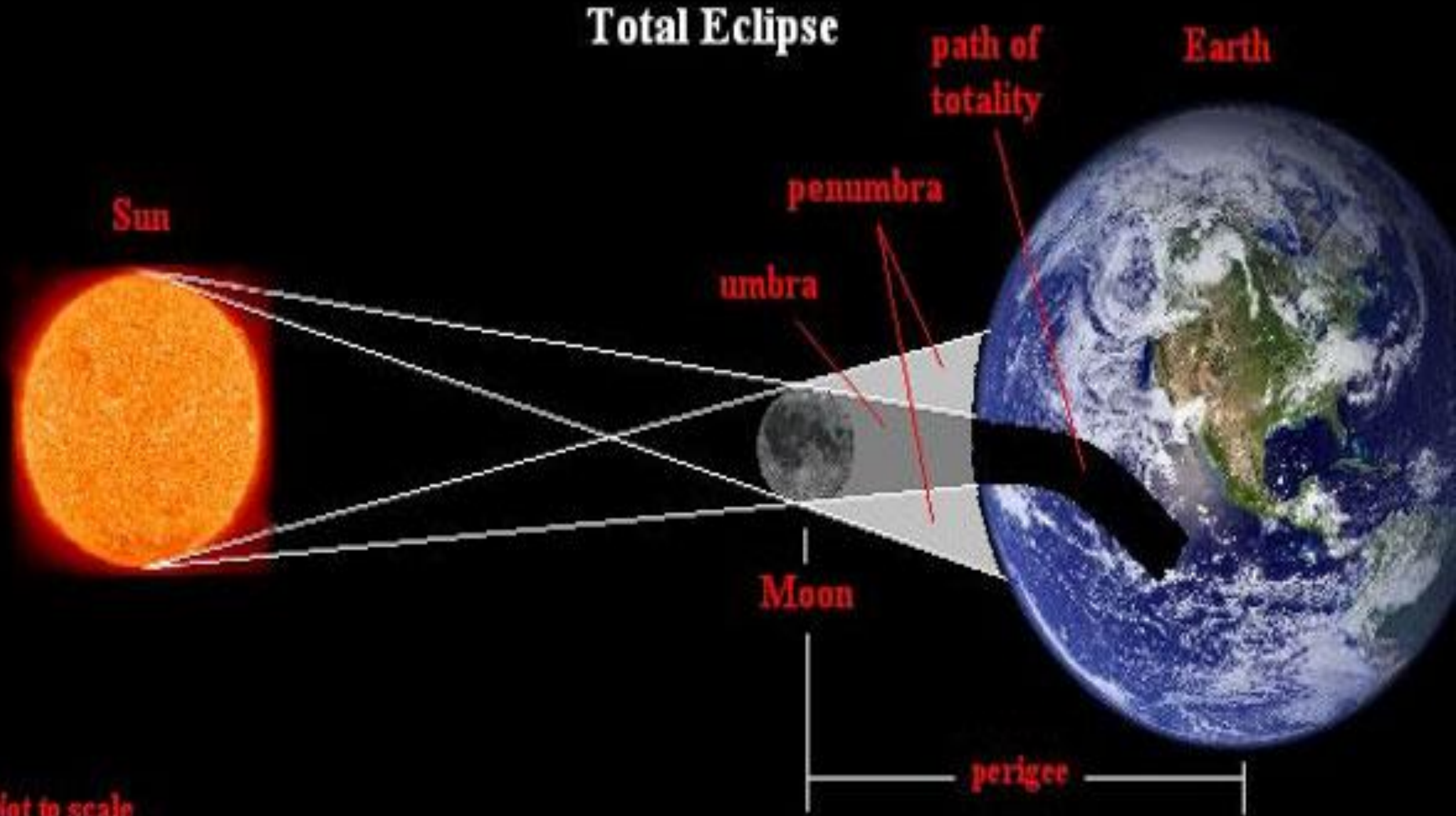

path of
totality

Earth

Sun

penumbra

umbra

Moon

perigee

Not to scale

Number of solar eclipses

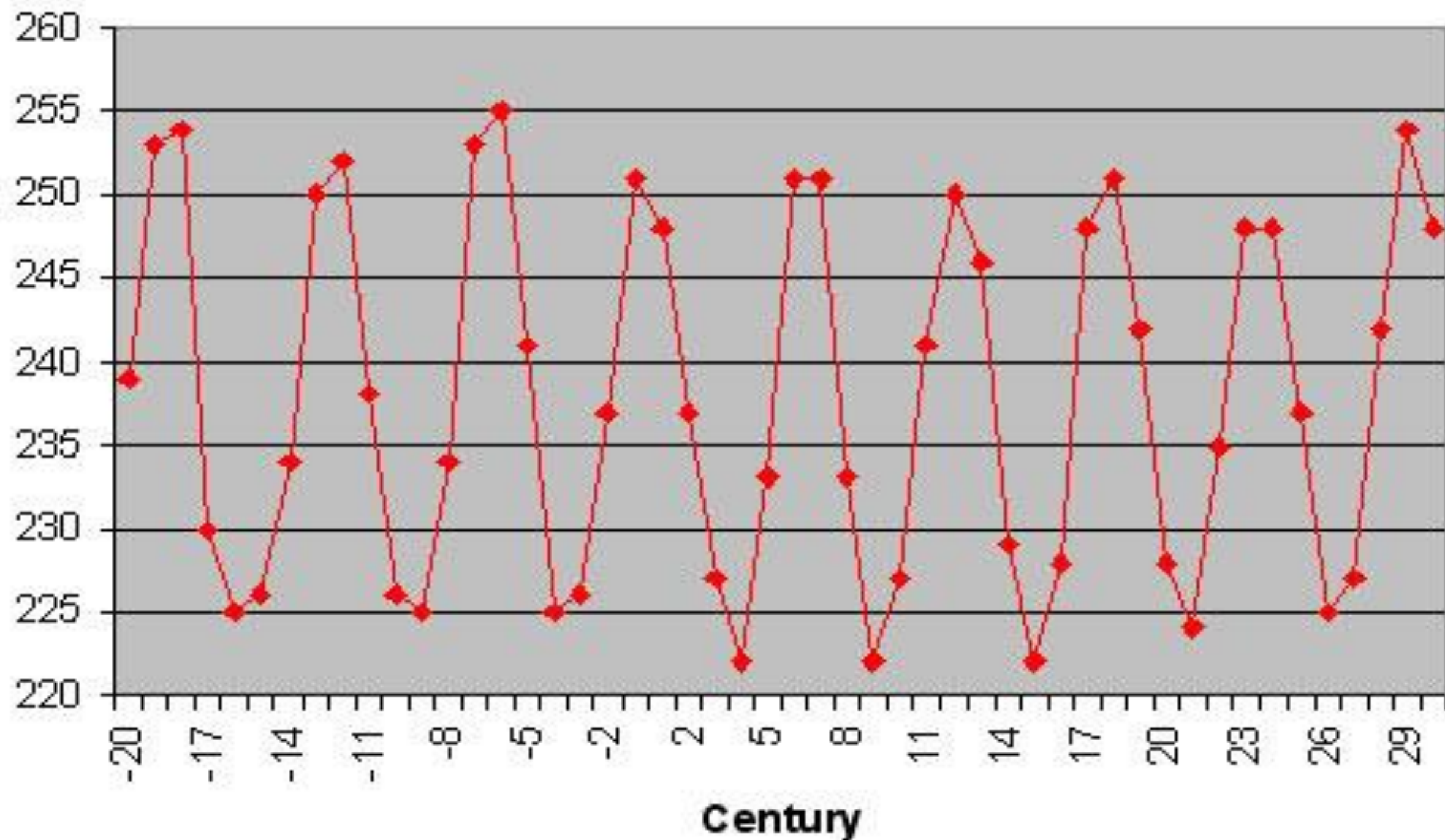

كسوف جزئي 27 يناير 632م



[HOME](#) [TOPICS](#) [CHRISTMAS](#)

'Jesus was born in June', astronomers claim

Astronomers have calculated that Christmas should be in June, by charting the appearance of the 'Christmas star' which the Bible says led the three Wise Men to Jesus.

CHRISTMAS• [Christmas](#)• [Christmas](#)• [Christmas](#)

فَاجَاءَهَا الْمَخَاضُ إِلَى جِذْعِ النَّخْلَةِ قَالَتْ يَا
لَيْتَنِي مِتُّ قَبْلَ هَذَا وَكُنْتُ نَسِيًّا مَنْسِيًّا.
فَنَادَاهَا مِنْ تَحْتِهَا أَلَا تَحْزَنِي قَدْ جَعَلَ رَبِّي
تَحْتِكَ سَرِيًّا. وَهَزِي إِلَيْكَ بِجِذْعِ النَّخْلَةِ
تُسَاقِطُ عَلَيْكَ رَطْبًا جَنِيًّا“
(مريم-23-25).



Metafizik

(ketuhanan, kalam, roh, jiwa, akal, takdir, akhirat, kebangkitan, malaikat, perkara ghaib, akhlak, nilai, tatasusila, psikologi, kebahagiaan dll)

Matematik

(arimetik, geometri, mantik, astronomi, aljabar, trigonometri, mekanik, dinamik, kalkulus, muzik dll)

Sains tabii

(sains hayat (biologi), fizik, kimia, kosmologi, geologi, geografi, perubatan, kajicuaca, kejuruteraan, farmakologi, botani, zoologi, optik dll)

Teknologi

2. TEKNOLOGI: BAGAIMANAKAH BERMULA?



i n v e n t



علي تسعة وثلاثين ليثم السطح الاعظم الذي هو سطح ره فيبلغ ذلك كله اربعة وستين فاخذنا جذرها وهو ثمانية وهو احد اضلاع السطح الاعظم فاذا نقصنا منه مثل ما زدنا عليه وهو خمسة بقي ثلثة وهو ضلع سطح اب الذي هو المال وهو جذره والمائل تسعة وهذه صورته

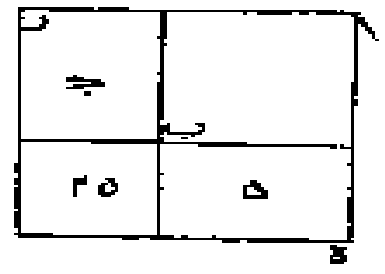

واما مال واحد وعشرون فدهما يعدل عشرة اجذاره فانا نجعل مال سطحا مربعيا مجهول الاضلاع وهو سطح اد ثم نضم اليه سطحا متوازي الاضلاع عرضه مثل احد اضلاع سطح اد وهو ضلع هـ والسطح اب فصار طول الطحين جميعا ضلع جـ هـ وقد علمنا ان طوله عشرة من العدد لان كل سطح مربع متساوي الاضلاع والزوايا فان احد اضلاعه مضروب في واحد جذر ذلك السطح وفي اثنين جذراه فلما قال مال واحد وعشرون يعدل عشرة اجذاره علمنا ان طول ضلع هـ عشرة اعداد لان ضلع جـ د جذر المال فتسما ضلع جـ هـ بنصفين علي نقطة

بسم الله الرحمن الرحيم
 هذا كتاب كتبه محمد بن موسى الخوارزمي واقتنىه بان قال
 ثبوتنا على نعمة بما هو اهله من محامدة التي ياداء ما اني ختمها
 على من تعبدوا من خلقه يقع اسم الشكر ويتوجب المزيد ويؤمن
 الغيرة والبر بوبينته وتذلل العزلة وخشوعا لعظمته بعثت
 سيدنا محمدا صلى الله عليه وسلم بالسوق على حين فترة من الرسل وتنبؤ
 من الحق ودروس من الهدى تبصر به من العمى واستغذ به من الملكة
 وكثر به من بعد الفلذ والغيبه بعد الشنات تبارك الله ربنا وتعال
 جده وتقدست اسماءه ولا اله غيره وصلى الله على سيدنا محمد النبي الامي
 وعلى اله وسلم و... في الارض من الخالية والاصم الما ضيب
 يكتبون الكتب ما يصنفون من صنوف العلم ورجو الحكمة نظر المن بعد
 واحتساب الاجر بقدر الطاقة وترجان ليحفظهم من اجر ذلك ويحفظهم
 وينبغي لهم من لسان الصديق ما يصغر في جنبه كثير مما كانوا يتكفون
 من المؤنة ويحلو له على انفسهم من المشقة في كشف اسرار العلم وغامض
 امتسار رجل سبق الى العلم يكن مستخرجا قبله فوترته من بعده وامسار
 شرع مما بنى الاولون ما كان مستغلفا فوضح طريقة وسهل متبليا
 وقرب ما خده وامتسار رجل وجد في بعض الكتب خلا لا ولم شعته
 واقام اوده واحسن الظن بصاحبه غير زار عليه ولا يفتخر بذلك
 بفعل نفسه ولا يسمي ما فضل الله سبحانه به الامام المأمون امير المؤمنين
 مع الخلافة التي جاز لها انما هو الرمة بلباسها وحلاة بزيتها من الغيرة
 في الايدى وتغريب الهه وادنائهم وبسط كنفه لهم ومعونته اياهم

To solve the equation $x^2 + 10x = 39$ by Al-Khwarizmi's "completing the square" method:

Start with a square of side x (which therefore represents x^2).

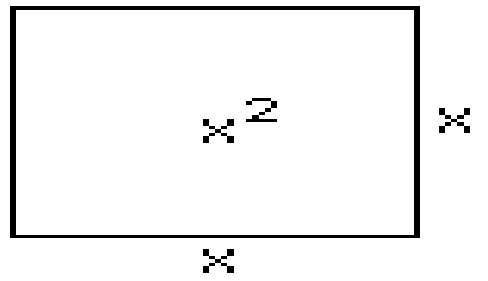

Add to this $10x$ by adding 4 rectangles of length x , and width $10/4$. Each small rectangle has an area $10x/4$ (or $5x/2$), total $10x$. We know this has a total area of 39.

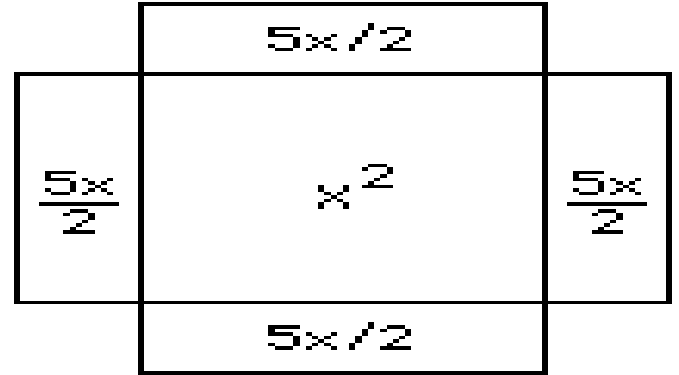

Complete the square by adding 4 little squares with side $5/2$ (area of each $25/4$). The outside square therefore has an area of $39 + (4 \times 25/4) = 39 + 25 = 64$. The sides of the outside square are therefore 8. But each side is of length $x + 5/2 + 5/2$, so $x + 5 = 8$, giving $x = 3$.

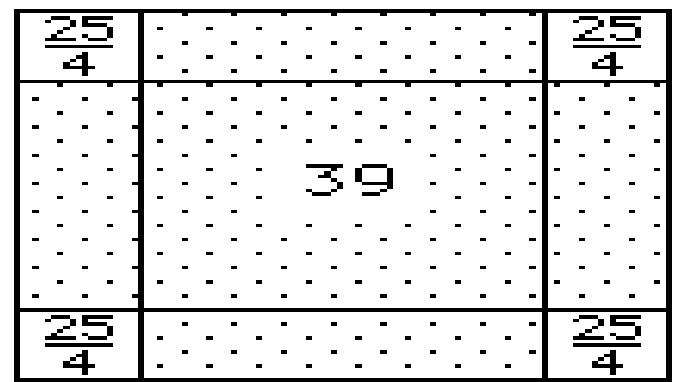

$$ax^2 + bx + c = 0$$

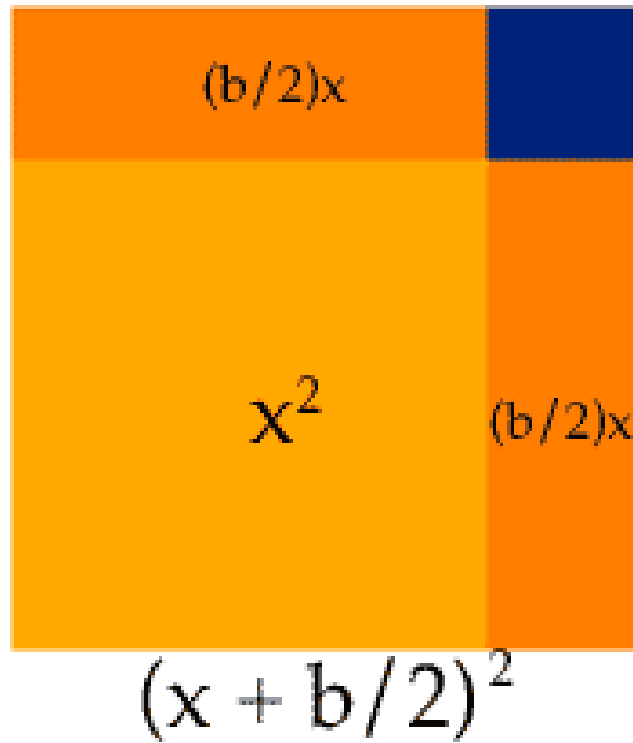

$$x^2 + \frac{b}{a}x + \left(\frac{b}{2a}\right)^2 = -\frac{c}{a} + \left(\frac{b}{2a}\right)^2$$

$$\left(x + \frac{b}{2a}\right)^2 = -\frac{c}{a} + \frac{b^2}{4a^2}$$

$$\left(x + \frac{b}{2a}\right)^2 = \frac{b^2 - 4ac}{4a^2}$$

$$x = \sqrt{\left(\frac{b}{2}\right)^2 + c} - \frac{b}{2}$$



C.F. GAUSS * 1777 † 1855

DEUTSCHE

BUNDESPOST

10

HEIDENBENZ

LSCHNELL



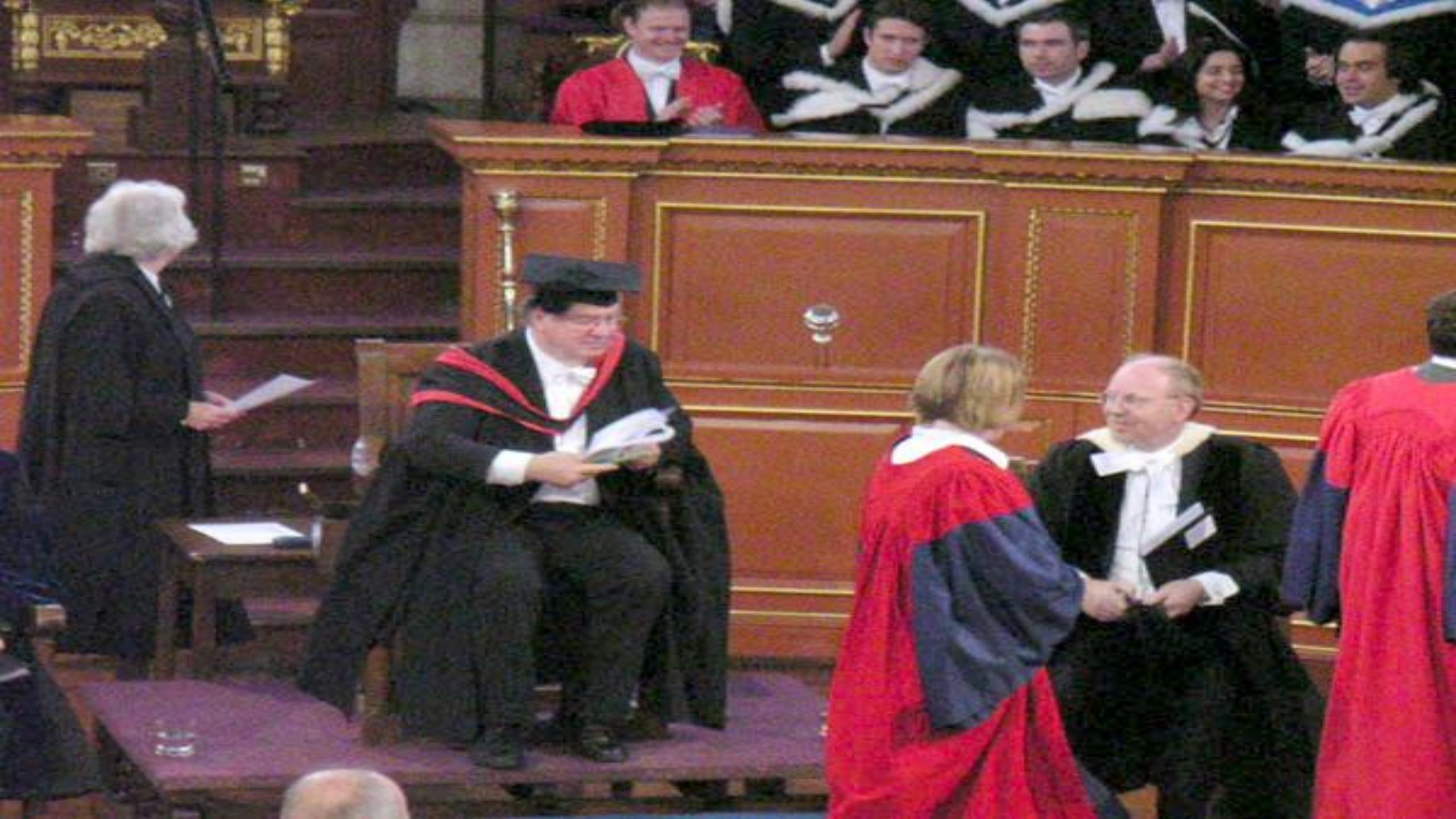

Al-Khwārizmī – 820 CE

Father of Algebra, Algorithm

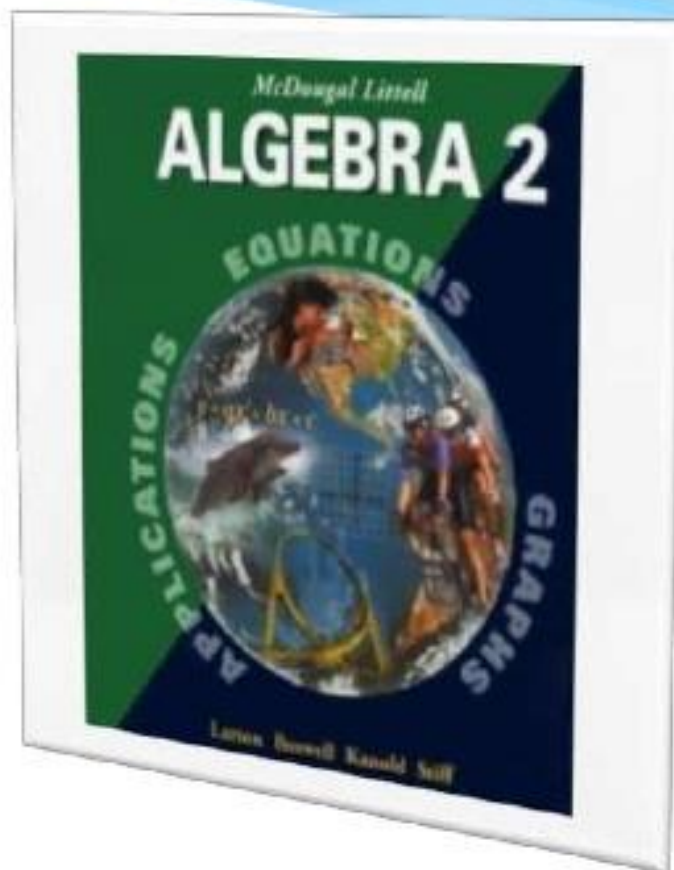

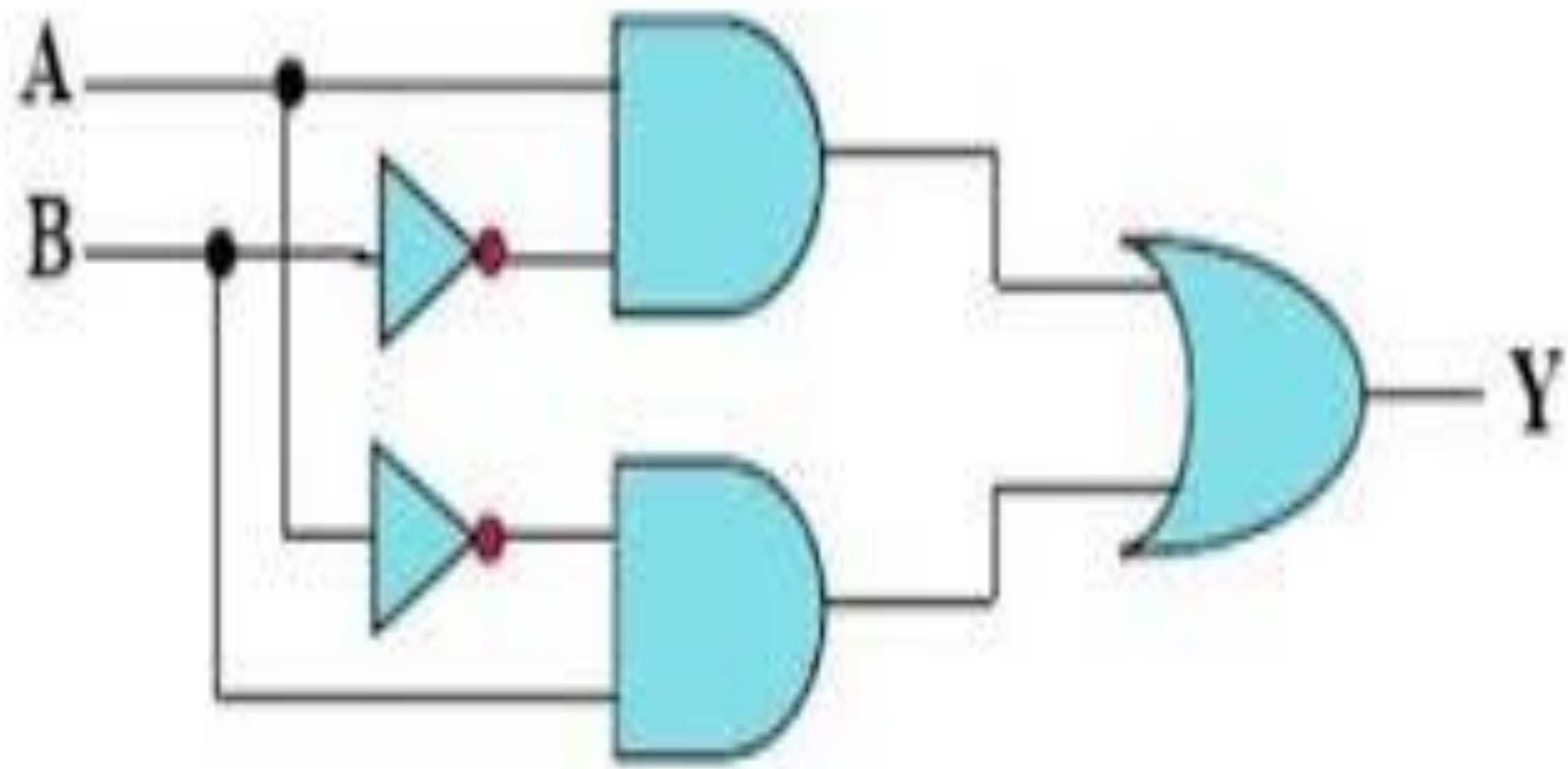



i n v e n t



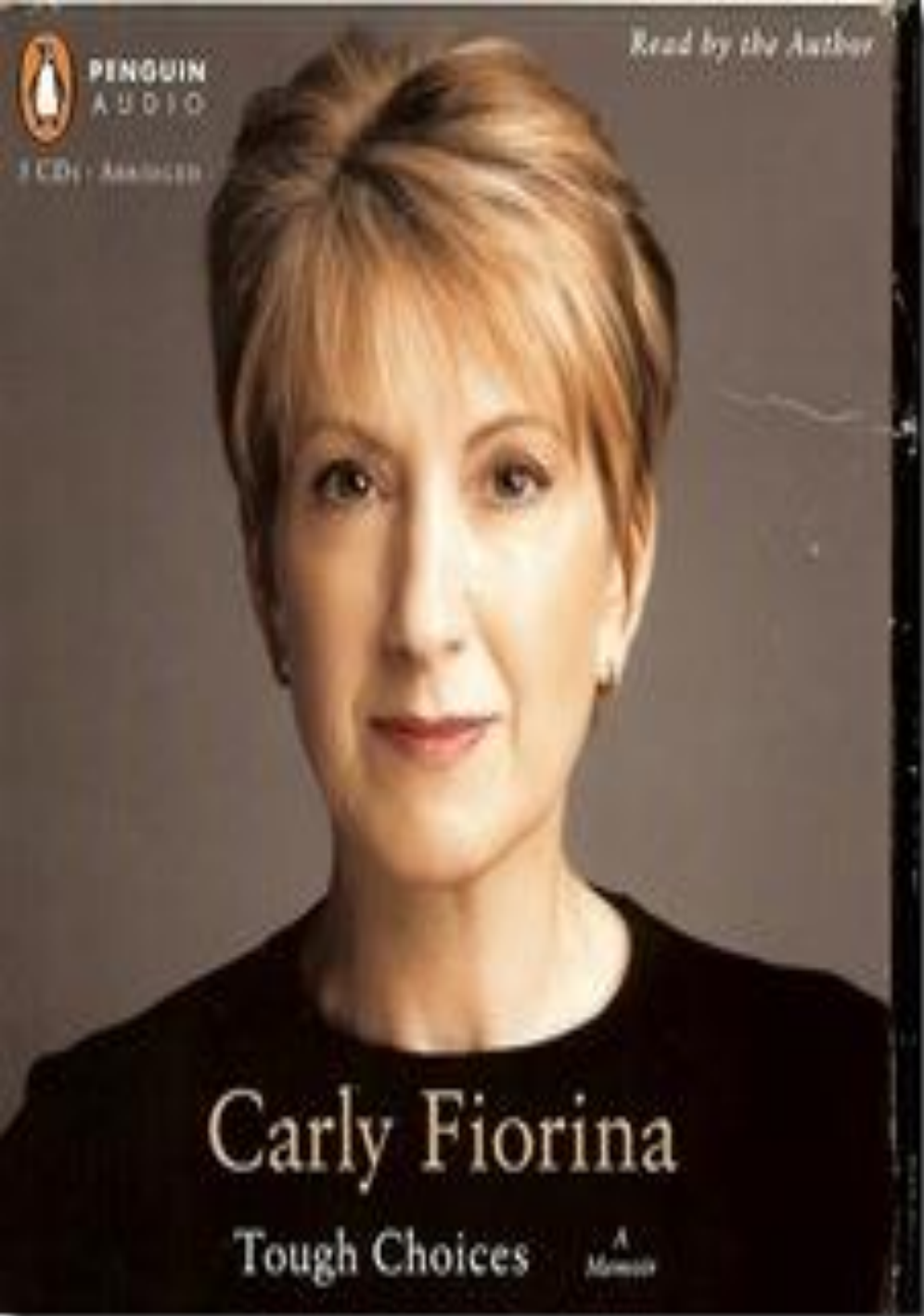

“There was once a civilization that was the greatest in the world.

And this civilization was driven more than anything, by invention. Its architects designed buildings that defied gravity. Its mathematicians created the algebra and algorithms that would enable the building of computers, and the creation of encryption. Its doctors examined the human body, and found new cures for disease. Its astronomers looked into the heavens, named the stars, and paved the way for space travel and exploration.

“When other nations were afraid of ideas, this civilization thrived on them, and kept them alive. When censors threatened to wipe out knowledge from past civilizations, this civilization kept the knowledge alive, and passed it on to others.

While modern Western civilization shares many of these traits, the civilization I’m talking about was the Islamic world from the year 800 to 1600, which included the Ottoman Empire and the courts of Baghdad, Damascus and Cairo, and enlightened rulers like Suleiman the Magnificent.

Although we are often unaware of our indebtedness to this other civilization, its gifts are very much a part of our heritage. The technology industry would not exist without the contributions of Arab mathematicians. Sufi poet-philosophers like Rumi challenged our notions of self and truth. Leaders like Suleiman contributed to our notions of tolerance and civic leadership” –
Fiorina HP CEO.

TOYOTA
DRIVING DETROIT
EVEN CRAZIER (P. 50)

CISCO STRUGGLING
TO BE A GROWTH
COMPANY AGAIN (P. 62)

SOUTHWEST
A NEW CEO'S BOLD
STRATEGY (P. 60)

The McGraw-Hill Companies

BusinessWeek

FEBRUARY 23, 2009

www.businessweek.com

CAN ANYONE SAVE HP?

BY BEN ELGIN (P. 28)

Plus: The Story Behind Carly's Ouster



MEMBER MAILING LIST MANAGEMENT
For advertising information, contact the circulation department
BY MAILING LIST MANAGEMENT
CIRCULATION DEPARTMENT
200 N. ZEEB RD.
HIGHTSTOWN, NJ 08520
TEL: 973-982-2000
FAX: 973-982-2001
E-MAIL: CIRCULATION@mcgraw-hill.com

It was able to create a continental super-state that stretched from ocean to ocean, and from northern climes to tropics and deserts. Within its dominion lived hundreds of millions of people, of different creeds and ethnic origins.

Virus Detected!

Now Testing
E:\Documents and Settings\AmerX\Local Settings\Temporary Internet Files\...\connect{3}.htm

Test statistics

Number of Files Tested:	1451	Bytes Tested:	274.5 MB
Number of Infected Files:	2	Last Virus Found:	Script/Exploit



Cancel Test

A Trojan Horse Was Found!



There is no reason to worry, though. avast! has stopped the malware before it could enter your computer. When you click on the "Abort connection" button, the download of the dangerous file will be canceled.

File name: http://www13.plala.or.jp/set/sb/download/beta/set/sbU15a3_P5w
 Malware name: Win32:Killwin-F [Trj]
 Malware type: Trojan Horse
 VPS version: 0634-0, 21/08/2006

Processing

<http://www.avast.com>

[Fill in our virus report to help us](#)

KASPERSKY



ANTI • VIRUS

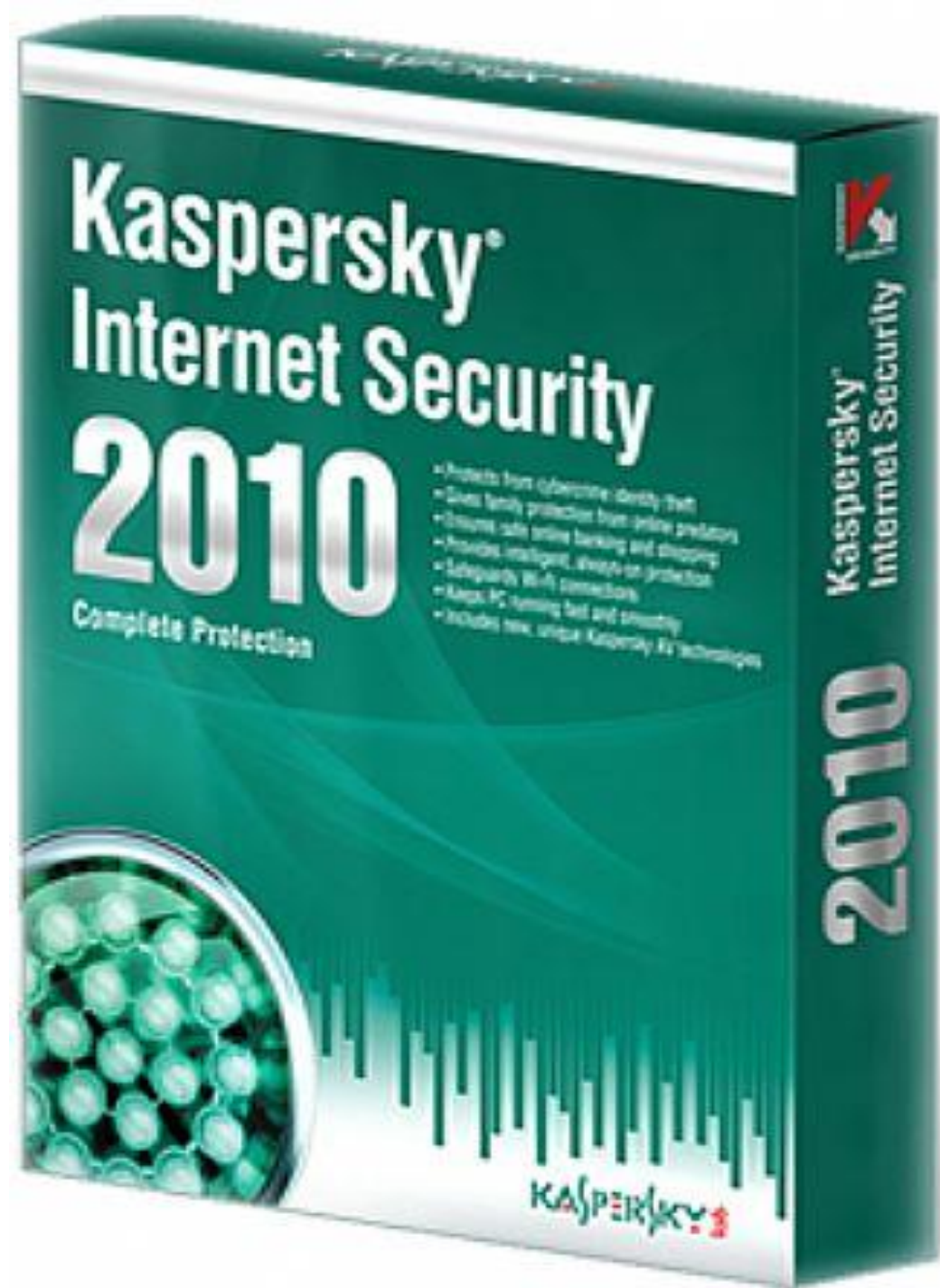



**NEW
WORLD
ORDER**



New World Order

Secret Organisations

Masons
Illuminati
Scull=crossbones
Bildberg ect

N - W - O AGENDA

No buying/selling
without Micro
Chip inserted in
all persons

ONE WORLD GOVERNMENT
ONE WORLD UNITED RELIGION
ONE WORLD BANKING - FORCE deficits - then devalue the existing currency then Crash the existing system totally then the four Union's NEW currencies are set to take over - People will lose their cash.
ONE WORLD ARMY - Millions will reject NWO and will rebel. Fluoride will be used to quell resistance.
ONE WORLD FOOD CONTROL - force farmers to use only GM seed - Plants/flowers will kill bees.
ONE WORLD WATER CONTROL - force gov's to use their systems through "treaties"
ONE WORLD MEDIA CONTROL by CFR
ONE WORLD HEALTH AUTHORITY - W.H.O giving Governments false fraudulent scientific reports eg: "global warming" when there's actually the opposite.. using chemicals - vaccines - manmade virus's and chips -

Dissidents and people who reject the NWO will be rounded up and placed into detention camps which are already built and staffed ready for inmates - In USA 132 Underground Military detention camps operational - In Europe three hundred underground Camps ready to take over 25 million persons - Check internet before it's closed down from exposing this information. - The false Fraudulent propaganda on "global warming from CO2 will be the TAX collector to pay NWO

EUROPEAN UNION

NTH AMERICAN UNION
Mexico-Canada -USA

PACIFIC UNION
APEC
AUSTRALIA ASIA

AFRICAN UNION

G 20 SUMMIT MEETINGS TO FORMULATE BASE LAWS FOR ALL UNIONS TO FOLLOW

IMF - CFR Etc

NATIONS - COUNTRIES

ELECTIONS CONTROLLED and funded by members CFR
Masons - Illuminati
Scull=crossbones
Bildberg ect

STATES - COUNCILS ORGANISATIONS

FEDERAL TO CONTROL STATES
STATES TO CONTROL LOCAL GOV
Media under instructions to push the NWO agenda treaties'

APPROVED RELIGIOUS ORGANISATIONS

Secret Organisations

Masons
Illuminati
Scull=crossbones
Bildberg ect

THE PEOPLE



Turkey

Lebanon

Syria

Iran

Israel

Jordan

Iraq

Jerusalem

Sinai

Saudi Arabia

Kuwait

Egypt

Red Sea

GREATER ISRAEL

According to Genesis 15:18-21

A map of Israel with a semi-transparent grey overlay. The map shows major cities like Be'er Sheva, Arad, Dimona, and Mitze Ramon. A dashed line outlines a region in the north and west. A blue line represents the Jordan River. Green squares are placed on the map. The text 'Israel' is centered above the main headline. The main headline reads 'Palestine has disappeared from Google Maps.' with 'disappeared' in yellow. The AJ logo is in the top right corner.

Israel

Palestine has **disappeared**
from Google Maps.

DEPOPULATION AGENDA

OUR WATER. OUR FOOD. OUR AIR.



“War and famine would not do. Instead, disease offered the most efficient and fastest way to kill the billions that must soon die if the population crisis is to be solved. AIDS is not an efficient killer because it is too slow. My favorite candidate for eliminating 90 percent of the world’s population is airborne Ebola (Ebola Reston), because it is both highly lethal and it kills in days, instead of years. We’ve got airborne diseases with 90 % mortality in humans. Killing humans. Think about that. You know, the bird flu’s good, too. For everyone who survives, he will have to bury nine” -

Dr. Eric Pianka University of Texas

**(Speech to an audience on population control.
He received a standing ovation.)**

www.facebook.com/Citizens.Action.Network



agenda 21



DEPOPULATION

Why did the US government
invent and patent EBOLA
Patent number #CA2741523A1
SWINE FLU

Patent number #8124101

The AIDS cure

Patent number #5676977

The CANCER cure

Patent number #6630507

Seems like they are trying to
cause an epidemic, making us ill,
then keeping us sick...

What are GMOs?



GMOs (genetically modified organisms) are created through biotechnology, also called genetic engineering.

DNA is altered artificially in a lab with genes from other plants, animals, viruses or bacteria to produce foreign compounds.

GMOs cannot occur in nature.





BILL GATES HAS A SECRET EUGENICS PLAN TO DEPOPULATE THE WORLD THROUGH VACCINES!



BECAUSE ALL EVIL VILLAINS ANNOUNCE THEIR MURDEROUS PLANS IN TED TALK PRESENTATIONS.

OWNS 500,000 SHARES OF MONSANTO, THE MOST EVIL COMPANY IN THE WORLD



CLAIMS HE WANTS TO MAKE THE WORLD A BETTER PLACE

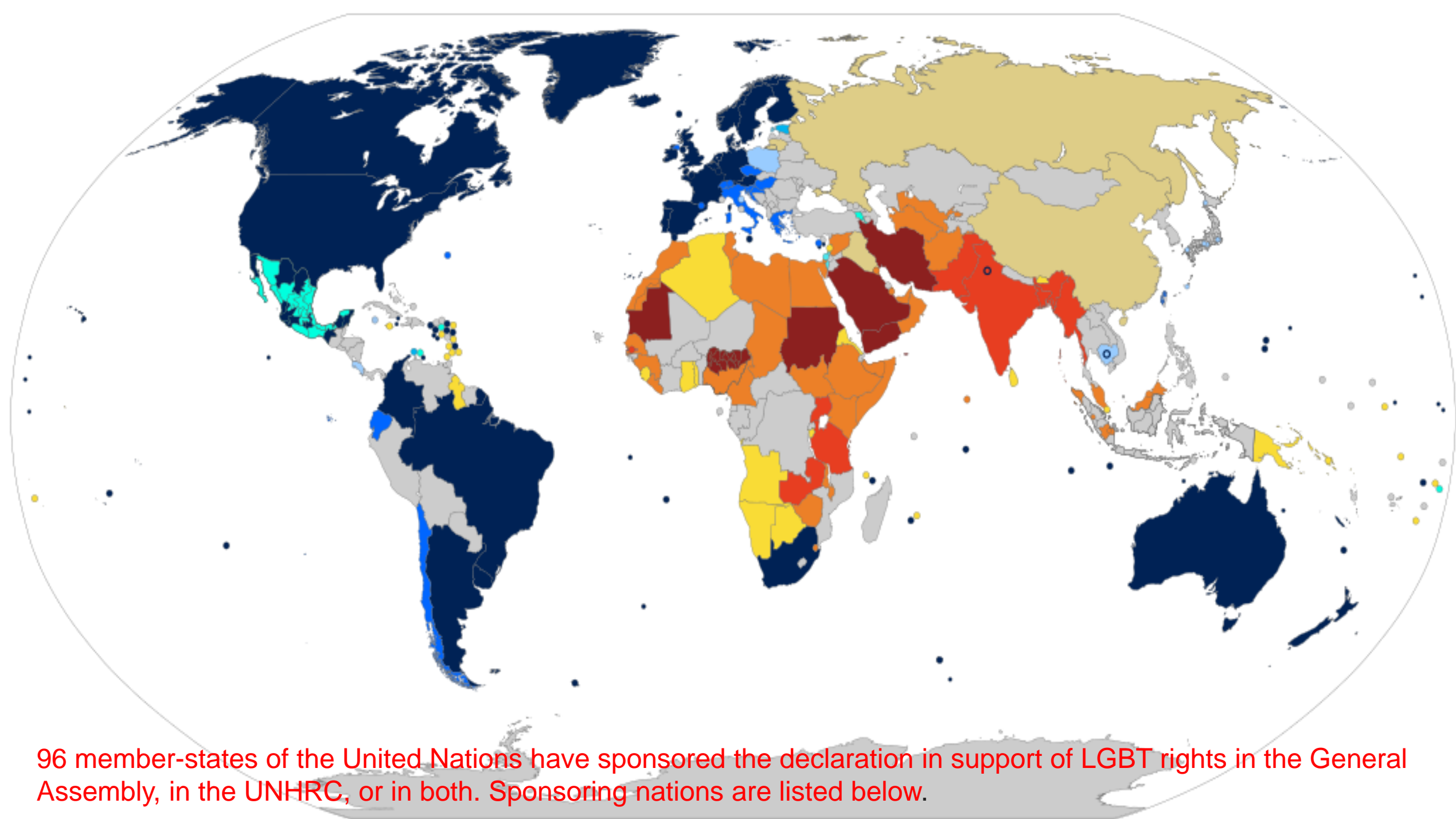

96 member-states of the United Nations have sponsored the declaration in support of LGBT rights in the General Assembly, in the UNHRC, or in both. Sponsoring nations are listed below.

Africa

- Cape Verde
- Central African Republic
- Gabon
- Guinea-Bissau
- Mauritius
- Rwanda (formerly opposition)
- Sao Tome and Principe
- Seychelles
- Sierra Leone (formerly opposition)
- South Africa

Americas

- Argentina
- Bahamas
- Bolivia
- Brazil
- Canada
- Chile
- Colombia (initiative)
- Costa Rica
- Cuba
- Dominica
- Dominican Republic
- Ecuador
- El Salvador

• Guatemala

- Honduras
- Mexico
- Nicaragua
- Panama
- Paraguay
- Peru
- United States (initiative)
- Uruguay
- Venezuela

Asia

- Israel
- Japan
- Mongolia
- Nepal
- Philippines
- South Korea
- Thailand
- Timor-Leste
- Vietnam

Europe

- Albania
- Andorra
- Armenia
- Austria
- Belgium
- Bosnia and Herzegovina

• Bulgaria

- Croatia
- Cyprus
- Czech Republic
- Denmark
- Estonia
- Finland
- France (initiative)
- Georgia
- Germany
- Greece
- Hungary
- Iceland
- Ireland
- Italy
- Latvia
- Liechtenstein
- Lithuania
- Luxembourg
- Macedonia^[23]
- Malta
- Moldova
- Monaco
- Montenegro
- Netherlands (initiative)
- Norway

• Poland

- Portugal
- Romania
- San Marino
- Serbia
- Slovakia
- Slovenia (initiative)
- Spain
- Sweden
- Switzerland
- Ukraine
- United Kingdom

Oceania

- Australia
- Federated States of Micronesia
- Fiji (formerly opposition)
- Marshall Islands
- Nauru
- New Zealand
- Palau
- Samoa
- Tuvalu
- Vanuatu



There are

20 million

new cases of STD infections

ANNUALLY

(in the U.S.)

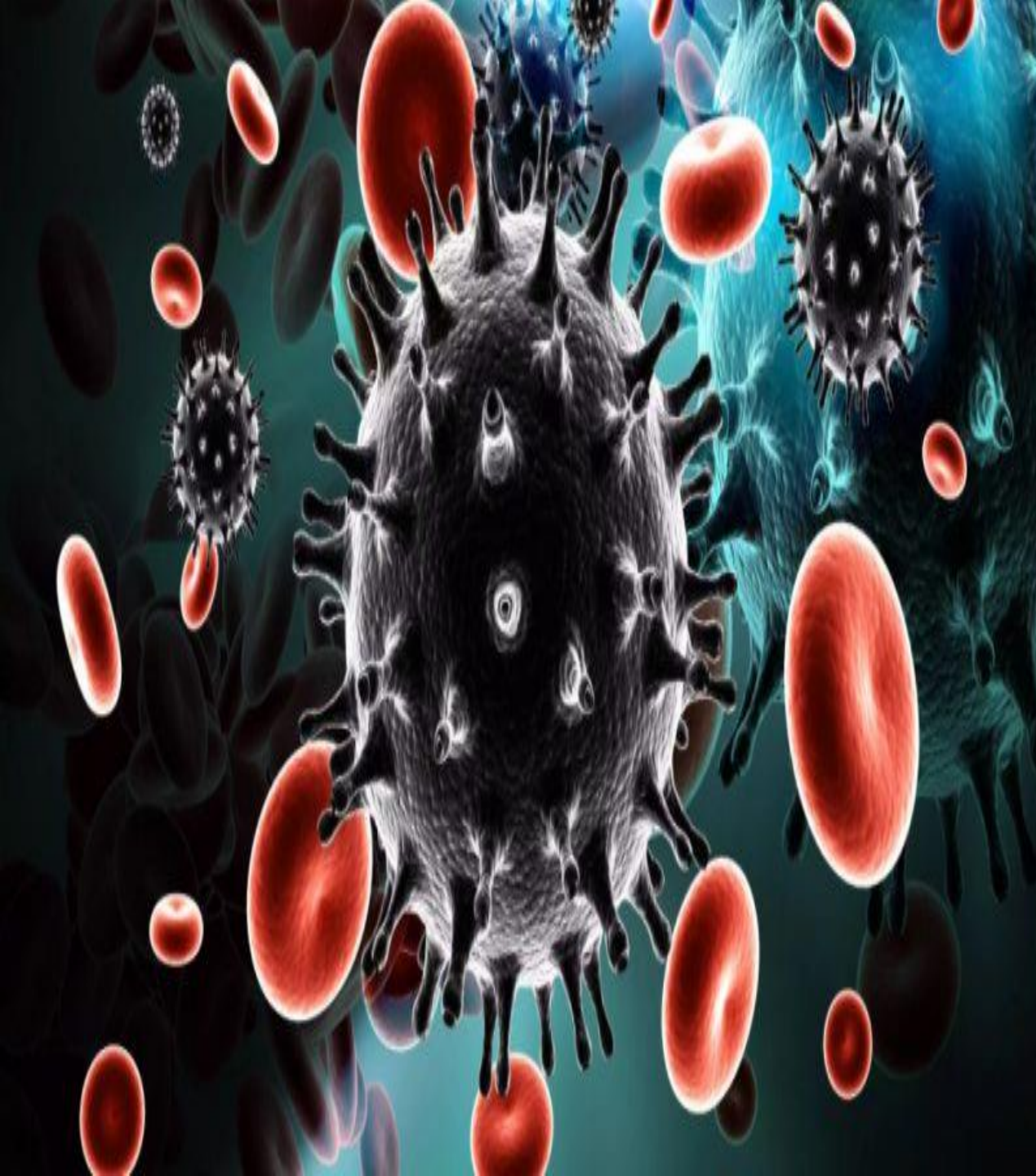

Malaysia among top 10 in new HIV infection

POSTED ON [23 JULY 2017](#) BY [ROBOCOP](#)

- Malaysia is one of the 10 countries which together accounted for over 95% of all new HIV infections in the Asia Pacific region, a report issued by the UN says.

The report, compiled by the Joint UN Programme on HIV/AIDS (UNAIDS) “Ending AIDS: Progress Towards the 90-90 Targets”, said the other nine Asia Pacific countries that had large constituencies of new HIV infections in 2016 are India, China, Indonesia, Pakistan, Vietnam, Myanmar, Papua New Guinea, the Philippines and Thailand.

Metafizik

(ketuhanan, kalam, roh, jiwa, akal, takdir, akhirat, kebangkitan, malaikat, perkara ghaib, akhlak, nilai, tatasusila, psikologi, kebahagiaan dll)

Matematik

(arimetik, geometri, mantik, astronomi, aljabar, trigonometri, mekanik, dinamik, kalkulus, muzik dll)

Sains tabii

(sains hayat (biologi), fizik, kimia, kosmologi, geologi, geografi, perubatan, kajicuaca, kejuruteraan, farmakologi, botani, zoologi, optik dll)

Teknologi

Metafizik

(ketuhanan, kalam, roh, jiwa, akal, takdir, akhirat, kebangkitan, malaikat, perkara ghaib, akhlak, nilai, tatasusila, psikologi, kebahagiaan dll)

Matematik

(aritmetik, geometri, mantik, astronomi, aljabar, trigonometri, mekanik, dinamik, kalkulus, muzik dll)

Sains tabii

(sains hayat (biologi), fizik, kimia, kosmologi, geologi, geografi, perubatan, kajiucua, kejuruteraan, farmakologi, botani, zoologi, optik dll)

Teknologi



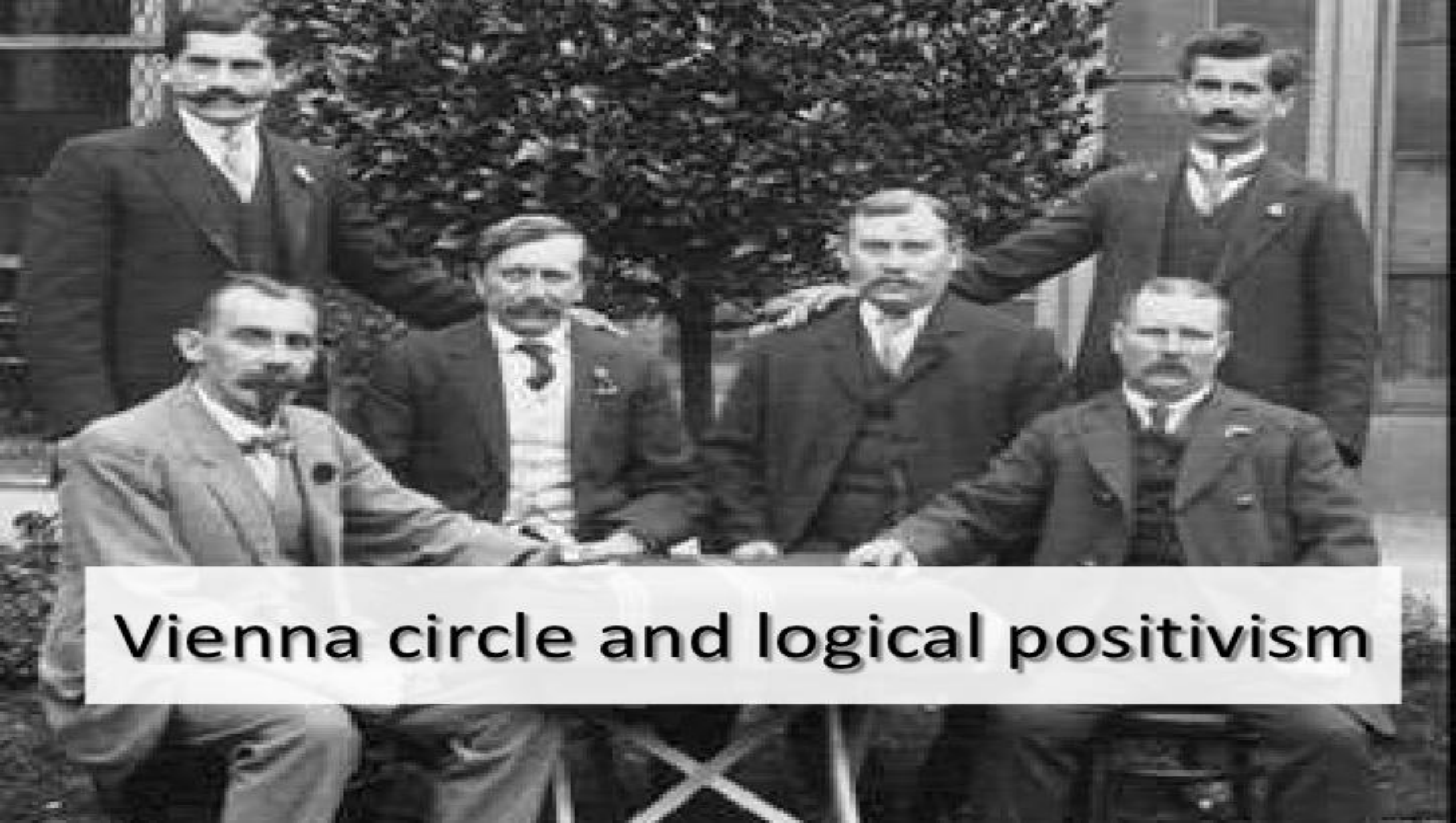

Vienna circle and logical positivism



Rudolf Carnap
(1891 – 1970)



Kurt Gödel
(1906 – 1978)

Ayer – All God talk is nonsense



By the end of this lesson **you will have:**

- Been introduced to the main ideas behind AJ Ayer's text.
- Have understood what is in your booklets and what is expected of you for independent study
- Have studied the first 3 sections of his text



**THOMSON REUTERS
FOUNDATION**

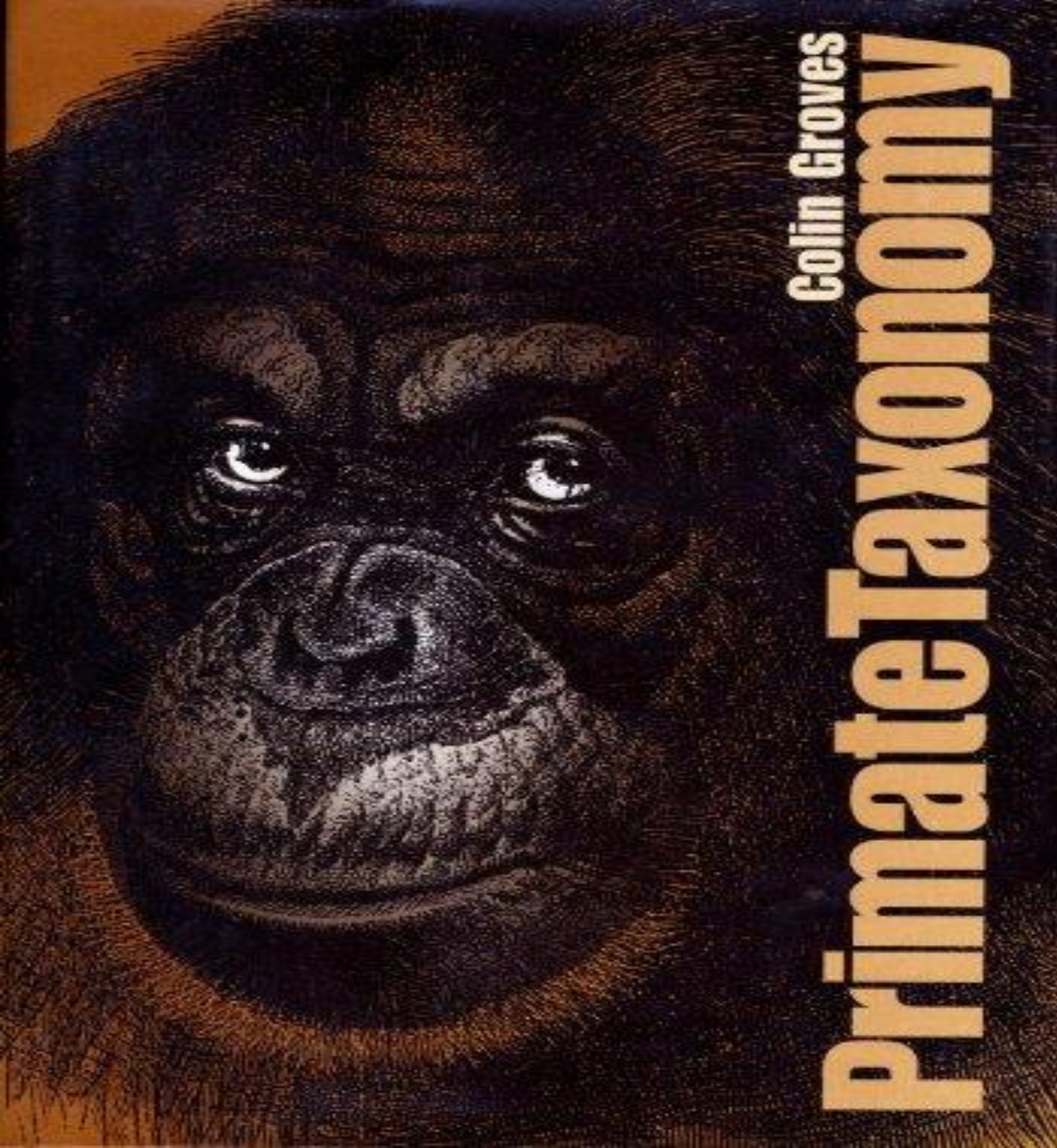

Colin Groves

Primate Taxonomy

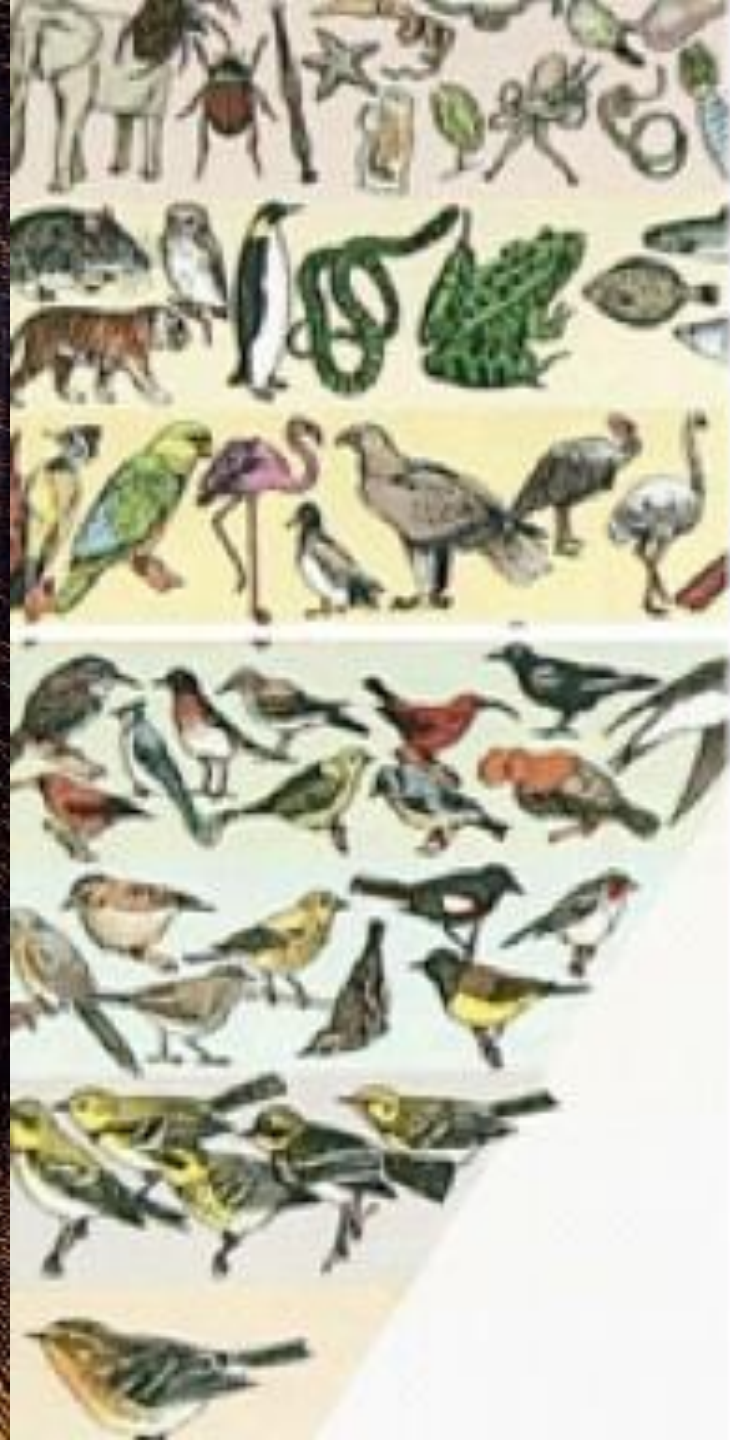

KINGDOM

PHYLUM

CLASS

ORDER

FAMILY

GENUS

SPECIES

Wolfgang Demtröder

WILEY-VCH

Molecular Physics

Theoretical Principles and Experimental Methods

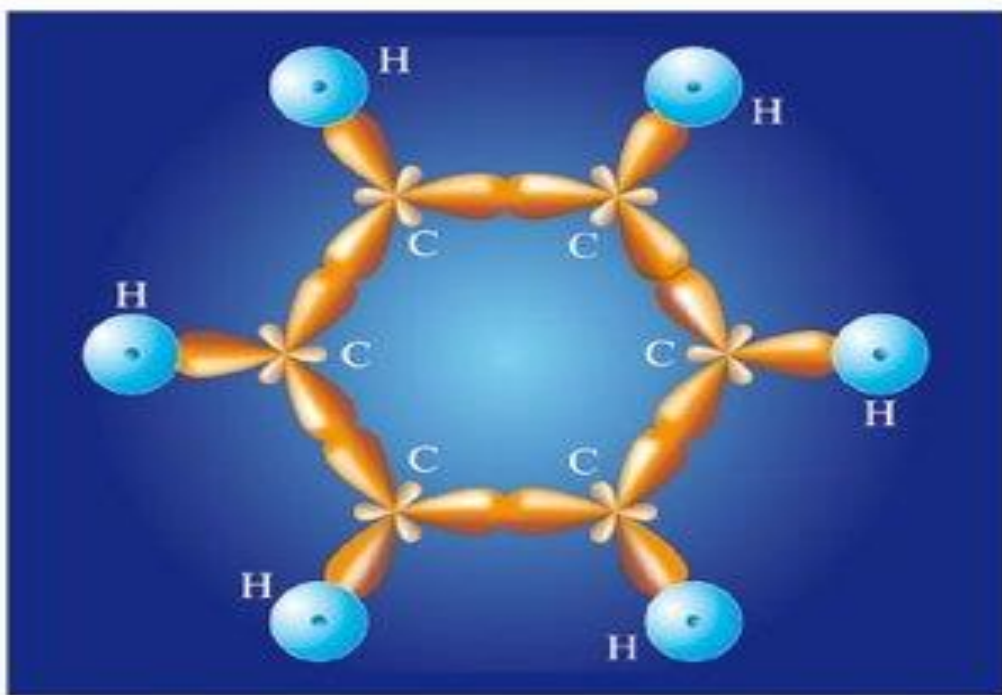

The cover of the textbook "Modern's abc of Chemistry For Class XII" by Dr. S.P. Jauhar. The background is blue with a pattern of red, white, and blue spheres representing atoms. A central graphic shows a black nucleus with a blue electron and yellow orbital paths. The text "MODERN'S abc OF CHEMISTRY For Class XII" is prominently displayed in yellow and red. The author's name "Dr. S.P. Jauhar" is at the bottom right. A circular badge in the bottom left corner states "covers all the new specifications UNDOUBTEDLY NO. 1". A small logo in the bottom right corner says "MODERN PUBLISHERS". A diagonal banner at the top left reads "STRICTLY ACCORDING TO THE NEW SYLLABUS". A circular seal at the top left corner indicates "AN ISO 9001:2000 CERTIFIED COMPANY". A small "MBD GROUP" logo is also visible.

REAL ANALYSIS

H.L. Royden • P.M. Fitzpatrick

Fourth
Edition

ASTRONOMY TODAY



FIFTH EDITION

CHAISSON • MCMILLAN

13 OKTOBER 2010



What is university for? (and what it should be like)

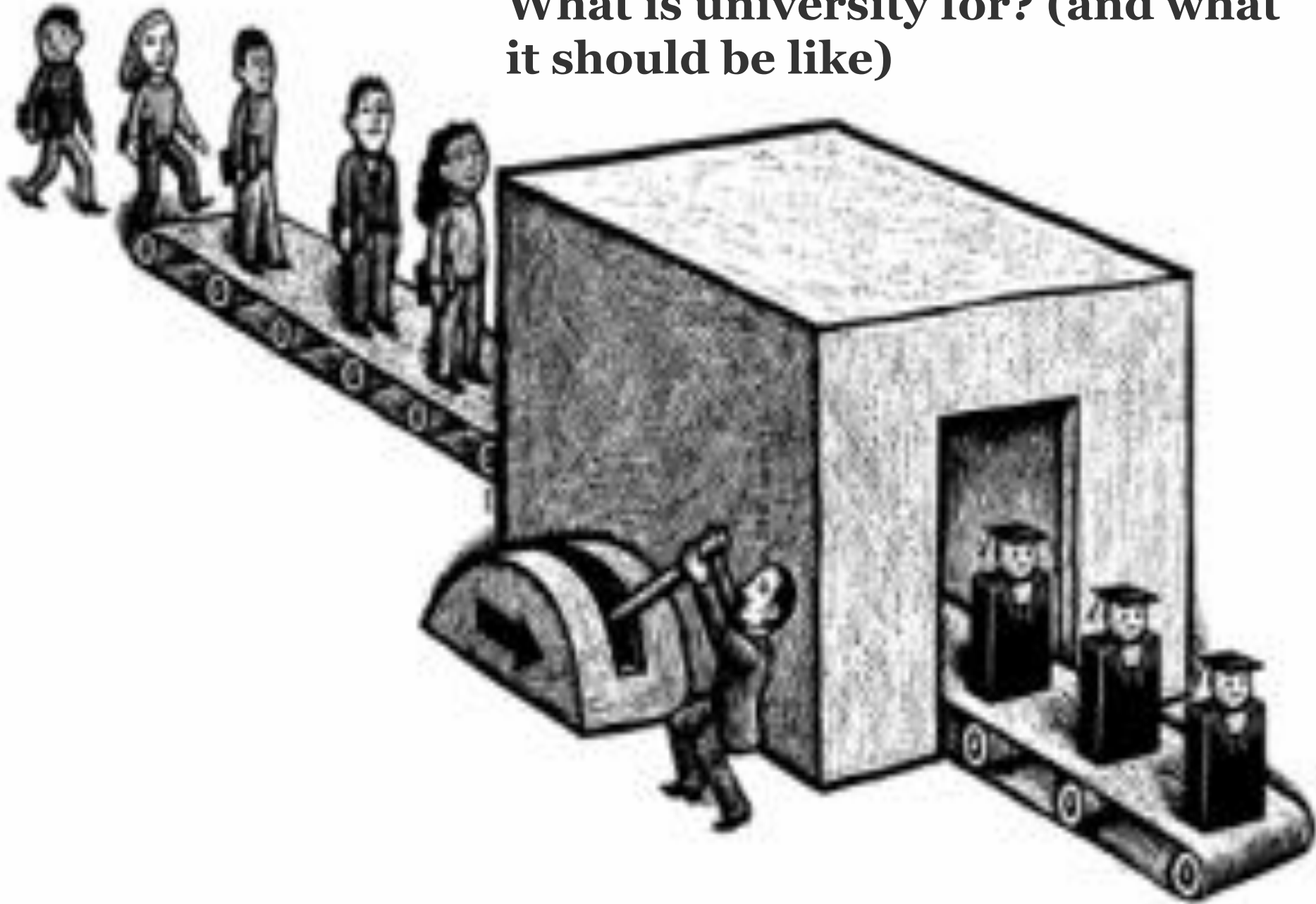



EXCELLENCE
WITHOUT
A SOUL

How a Great University Forgot Education

HARRY R. LEWIS
Former Dean of Harvard College

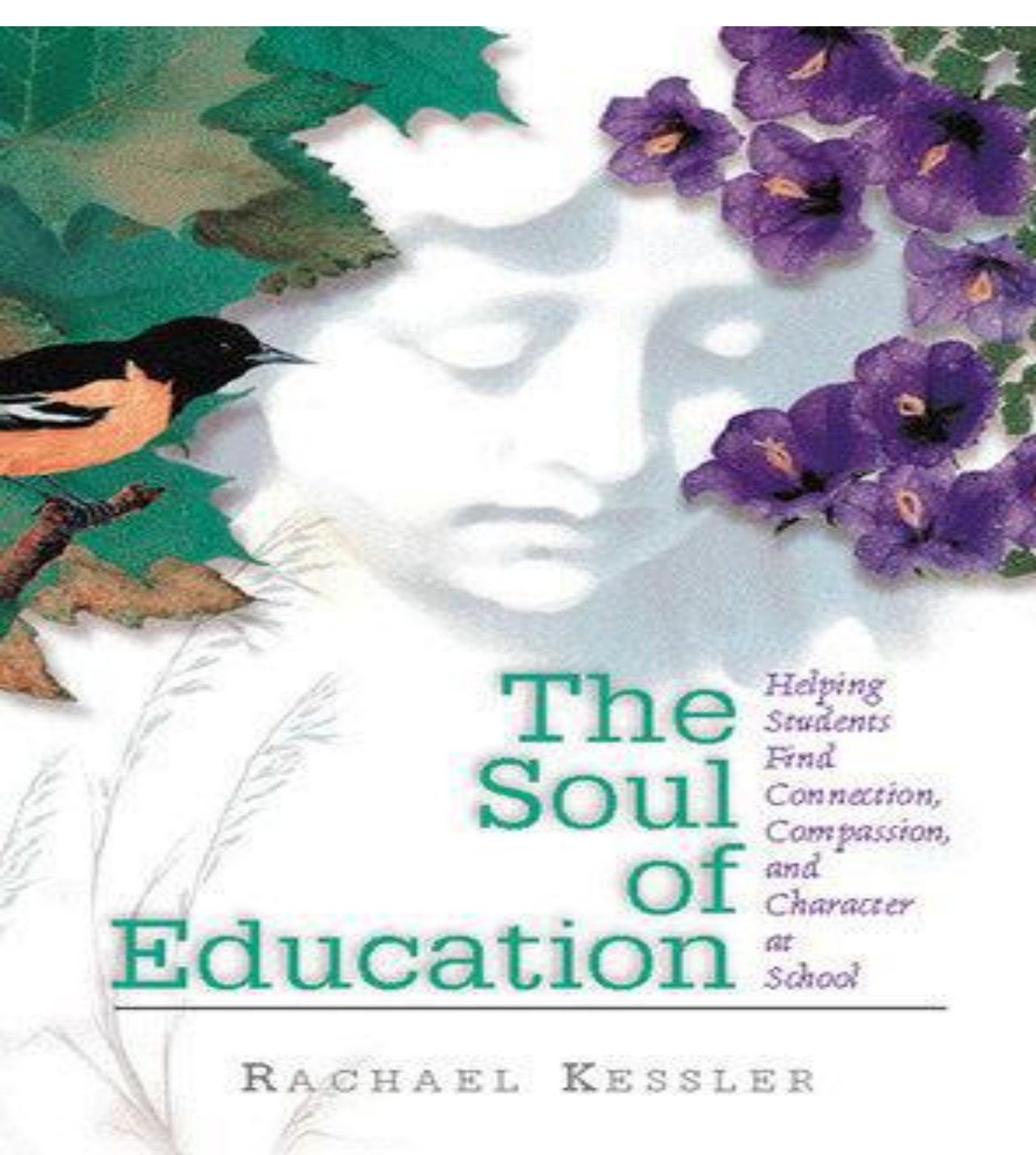

CORPORATIZATION, THE ASSAULT ON ACADEMIC FREEDOM,
AND THE END OF THE AMERICAN UNIVERSITY

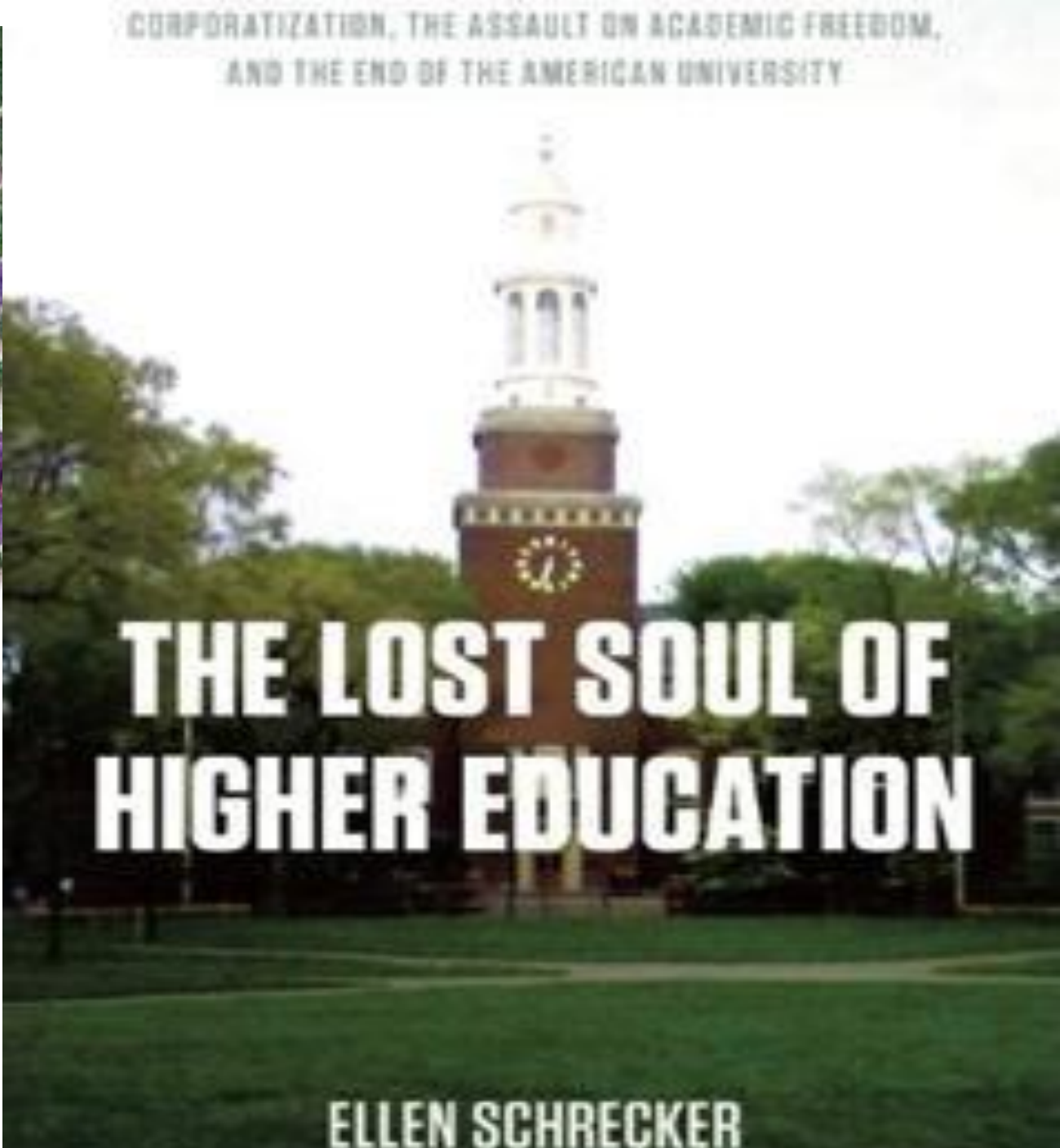

MODEL ULUL ALBAB

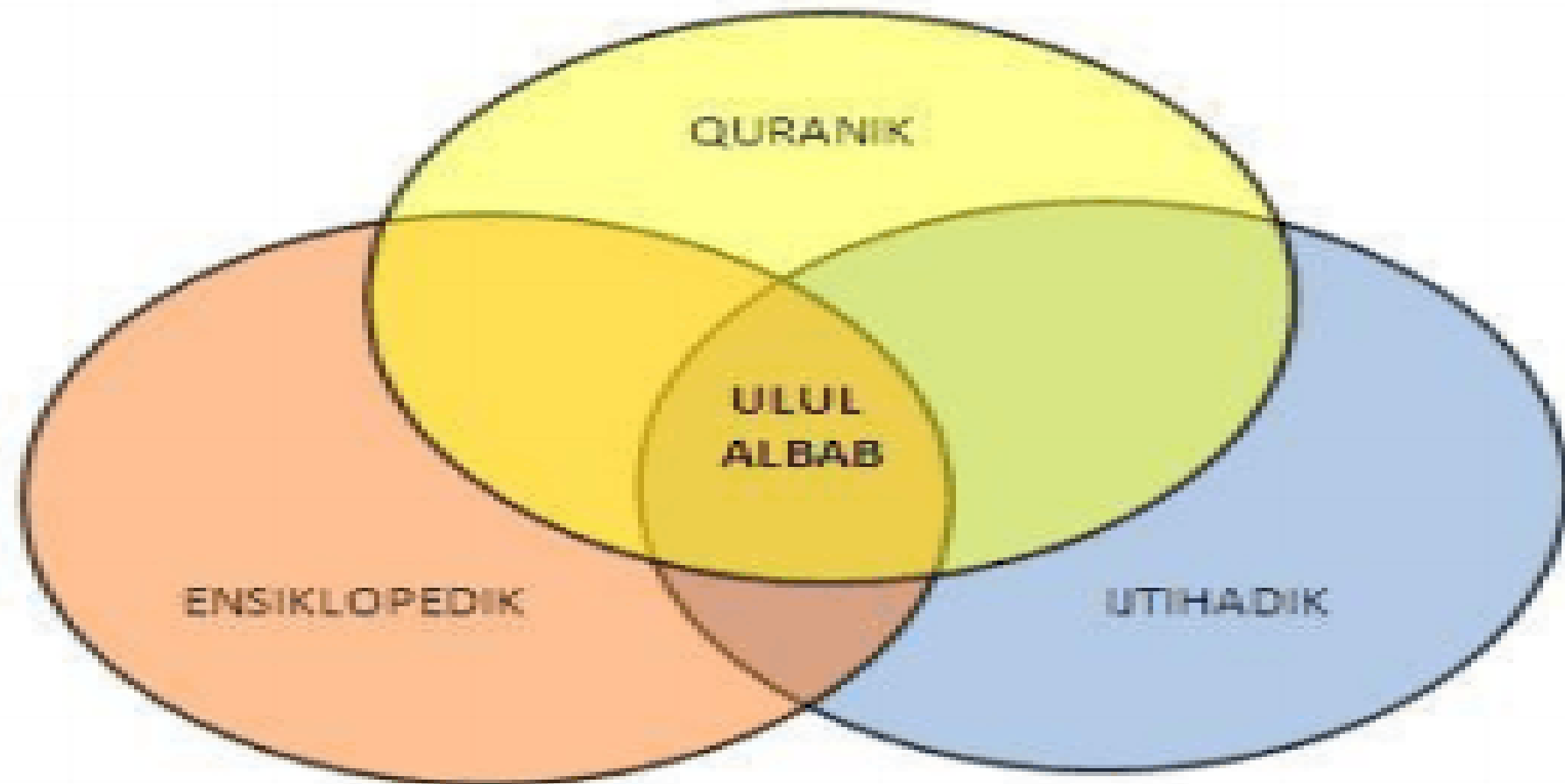

باب Albab

PUSAT ULUL ALBAB

ULUL ALBAB CENTRE



UNIVERSITI
PENDIDIKAN
SULTAN IDRIS
اونيورسيتي فنديديقن سلطان ادريس



"MENGINTEGRASIKAN ILMU NAQLI DAN AQLI
UNTUK MENTRANSFORMASIKAN DAN MENGHASILKAN
NILAI KEPADA NEGARA, UMMAH, DAN MANUSIA SEJAGAT"



**Scientists prove Qur'an
to be the word of God**

By Ayamem1 Channel



Professor William Brown

In scientific research published in the renowned scientific journal *Journal of Plant Molecular Biology*, a team of scientists found that some Americans are tropical plants issued Zbmat ultrasound were monitored and recorded with the latest scientific instruments ...



The famous French oceanographer **Mr Jacques Yves Cousteau**, has embraced Islam after his amazing undersea discovery was confirmed by the Holy Qur'an the last and final revealed guidance of Allah (God Almighty) for the whole of Mankind and Jinns.

One day somewhere in deep ocean, Mr Jacques Yves Cousteau was doing some undersea exploration when he discovered that within the salty sea water there were several spring of sweet palatable water.

What amazed him most was the fact that the sweet water of the springs was not mingling with the salty water of the sea. For a long time he tried to find plausible excuse for this phenomena, but to no avail.

"It is He (Allah) Who has let free the two bodies of flowing water : One palatable and sweet, and the other salty and bitter; yet has He (Allah) made a barrier between them, a portion that is forbidden to be passed" –

(Sura 25 Al-Furqan : Verse 53)

درجة الحرارة



ينابيع عذبة تحت قاع الخليج

ماء عذب

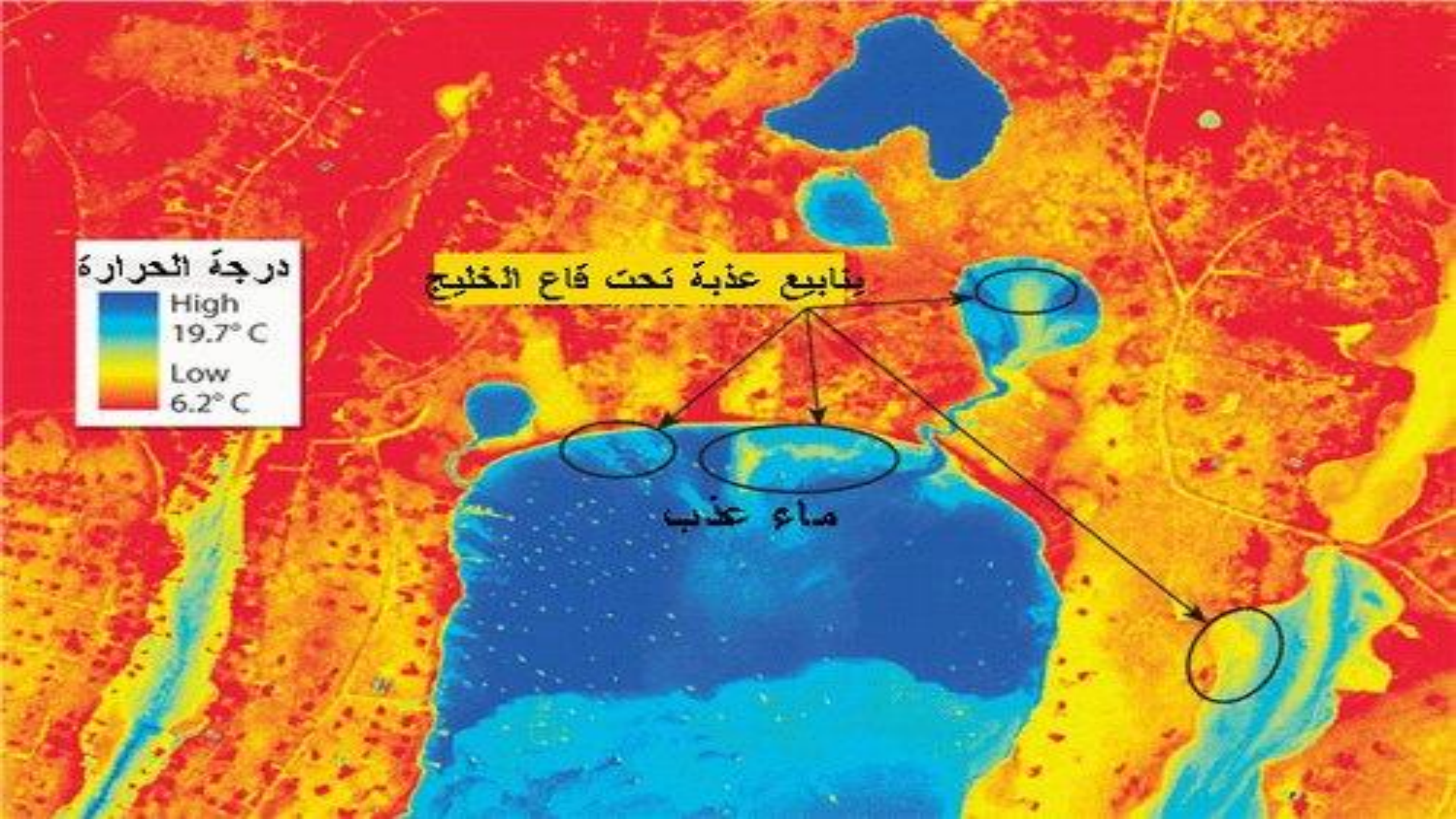



﴿ وَهُوَ الَّذِي مَرَجَ
الْبَحْرَيْنِ هَذَا عَذْبٌ
فُرَاتٌ وَهَذَا مِلْحٌ
أَجَاجٌ وَجَعَلَ
بَيْنَهُمَا بَرْزَخًا
وَحِجْرًا مَحْجُورًا ﴾

[الفرقان: 53].

Daripada Penulis Buku **BESTSELLER**
DR MAT ROFA ISMAIL
Editor Rohidzir Rais

Travelog & Dakwah

DARI KE
BANGI
KE
SEOUL

Menelusuri Kerdipan
ISLAM di Bumi KOREA..

Daripada Penulis Buku **BESTSELLER**
DR MAT ROFA ISMAIL
Editor Rohidzir Rais

Travelog & Dakwah

DARI KE
BANGI
KE
SEOUL

Menelusuri Kerdipan
ISLAM di Bumi KOREA..

